

ITALIA TRACK ARM COLLECTION



All dimensions are given in inches. See the attached "Dimensions Diagram" sheet for more information on the keys used in this chart.

	A	B	C	D	E	F	G	H	I	J	K	L		M	N				O	P	Q	R	S
	OVERALL WIDTH	OVERALL DEPTH	OVERALL HEIGHT	FRAME HEIGHT	SEAT HEIGHT	ARM HEIGHT	FOOT HEIGHT	SEAT HEIGHT (FLOOR TO CUSHION SEAM)	SEAT HEIGHT (FLOOR TO FRAME)	INSIDE SEAT WIDTH	INSIDE SEAT DEPTH W/ BACK CUSHION	INSIDE SEAT DEPTH W/O BACK CUSHION	INSIDE BACK HEIGHT W/ SEAT & BACK CUSHIONS	INSIDE BACK HEIGHT W/ SEAT CUSHION	INSIDE BACK HEIGHT W/O SEAT OR BACK CUSHION	# OF BACK CUSHIONS	# OF SEAT CUSHIONS	ACCENT PILLOWS	ARM HEIGHT W/ SEAT CUSHION	ARM HEIGHT W/O SEAT CUSHION	ARM WIDTH	SLEEPER DEPTH OVERALL	SLEEPER DEPTH INSIDE
6' PETITE SOFA	72	37	32½	27	19¼	22½	7½	18¾	12	63	23	28¾	13¾	7¾	15	2	1	0	3¾	10½	4½	-	-
6' CLASSIC SOFA	72	41	32½	27	19¼	22½	7½	18¾	12	60	19	31¾	13¾	7¾	15	2	1	2	3¾	10½	6	-	-
7' PETITE SOFA	84	37	32½	27	19¼	22½	7½	18¾	12	75	23	28¾	13¾	7¾	15	2	1	0	3¾	10½	4½	-	-
7' CLASSIC SOFA	84	41	32½	27	19¼	22½	7½	18¾	12	72	19	31¾	13¾	7¾	15	2	1	2	3¾	10½	6	-	-
7' LUXE SOFA	84	45	32½	27	19¼	22½	7½	18¾	12	72	23	35¾	13¾	7¾	15	2	1	2	3¾	10½	6	-	-
8' PETITE SOFA	96	37	32½	27	19¼	22½	7½	18¾	12	87	23	28¾	13¾	7¾	15	2	1	0	3¾	10½	4½	-	-
8' CLASSIC SOFA	96	41	32½	27	19¼	22½	7½	18¾	12	84	19	31¾	13¾	7¾	15	2	1	2	3¾	10½	6	-	-
8' LUXE SOFA	96	45	32½	27	19¼	22½	7½	18¾	12	84	23	35¾	13¾	7¾	15	2	1	2	3¾	10½	6	-	-
9' PETITE SOFA	108	37	32½	27	19¼	22½	7½	18¾	12	99	23	28¾	13¾	7¾	15	2	1	0	3¾	10½	4½	-	-
9' CLASSIC SOFA	108	41	32½	27	19¼	22½	7½	18¾	12	96	19	31¾	13¾	7¾	15	2	1	2	3¾	10½	6	-	-
9' LUXE SOFA	108	45	32½	27	19¼	22½	7½	18¾	12	96	23	35¾	13¾	7¾	15	2	1	2	3¾	10½	6	-	-
10' PETITE SOFA	120	37	32½	27	19¼	22½	7½	18¾	12	111	23	28¾	13¾	7¾	15	2	1	0	3¾	10½	4½	-	-
10' CLASSIC SOFA	120	41	32½	27	19¼	22½	7½	18¾	12	108	19	31¾	13¾	7¾	15	2	1	2	3¾	10½	6	-	-
10' LUXE SOFA	120	45	32½	27	19¼	22½	7½	18¾	12	108	23	35¾	13¾	7¾	15	2	1	2	3¾	10½	6	-	-

ITALIA TRACK ARM COLLECTION



All dimensions are given in inches. See the attached "Dimensions Diagram" sheet for more information on the keys used in this chart.

	A	B	C	D	E	F	G	H	I	J	K	L		M	N				O	P	Q	R	S
	OVERALL WIDTH	OVERALL DEPTH	OVERALL HEIGHT	FRAME HEIGHT	SEAT HEIGHT	ARM HEIGHT	FOOT HEIGHT	SEAT HEIGHT (FLOOR TO CUSHION SEAM)	SEAT HEIGHT (FLOOR TO FRAME)	INSIDE SEAT WIDTH	INSIDE SEAT DEPTH W/ BACK CUSHION	INSIDE SEAT DEPTH W/O BACK CUSHION	INSIDE BACK HEIGHT W/ SEAT & BACK CUSHIONS	INSIDE BACK HEIGHT W/ SEAT CUSHION	INSIDE BACK HEIGHT W/O SEAT OR BACK CUSHION	# OF BACK CUSHIONS	# OF SEAT CUSHIONS	ACCENT PILLOWS	ARM HEIGHT W/ SEAT CUSHION	ARM HEIGHT W/O SEAT CUSHION	ARM WIDTH	SLEEPER DEPTH OVERALL	SLEEPER DEPTH INSIDE
PETTE CHAIR	35	37	32½	27	19¼	22½	7½	18¾	12	26	23	28¾	13¾	7¾	15	1	1	0	3¾	10½	4½	-	-
CLASSIC CHAIR	40	41	32½	27	19¼	22½	7½	18¾	12	28	19	31¾	13¾	7¾	15	1	1	1	3¾	10½	6	-	-
LUXE CHAIR	42	45	32½	27	19¼	22½	7½	18¾	12	30	23	35¾	13¾	7¾	15	1	1	1	3¾	10½	6	-	-
CLASSIC CHAIR-AND-A-HALF	46	41	32½	27	19¼	22½	7½	18¾	12	34	19	31¾	13¾	7¾	15	1	1	1	3¾	10½	6	-	-
LUXE CHAIR-AND-A-HALF	48	45	32½	27	19¼	22½	7½	18¾	12	36	23	35¾	13¾	7¾	15	1	1	1	3¾	10½	6	-	-
SMALL BENCH	57	28	20½	20½	18½	20½	7½	17	12	46	-	-	-	-	-	0	1	-	-	-	-	-	-
LARGE BENCH	92	39½	20½	20½	18½	20½	7½	17	12	77	-	-	-	-	-	0	1	-	-	-	-	-	-
PETTE OTTOMAN	30	26	18½	18½	18½	-	7½	17	12	30	-	-	-	-	-	0	1	-	-	-	-	-	-
LUXE OTTOMAN	34	28	18½	18½	18½	-	7½	17	12	34	-	-	-	-	-	0	1	-	-	-	-	-	-
COFFEE OTTOMAN	57	28	18½	18½	18½	-	7½	17	12	57	-	-	-	-	-	0	1	-	-	-	-	-	-
5' PETTE ARMLESS SOFA	60	37	32½	27	19¼	-	7½	18¾	12	60	23	28¾	13¾	7¾	15	2	1	0	-	-	-	-	-
5' CLASSIC ARMLESS SOFA	60	41	32½	27	19¼	-	7½	18¾	12	60	25	31¾	13¾	7¾	15	2	1	0	-	-	-	-	-
6' PETTE ARMLESS SOFA	72	37	32½	27	19¼	-	7½	18¾	12	72	23	28¾	13¾	7¾	15	2	1	0	-	-	-	-	-
6' CLASSIC ARMLESS SOFA	72	41	32½	27	19¼	-	7½	18¾	12	72	25	31¾	13¾	7¾	15	2	1	0	-	-	-	-	-

ITALIA TRACK ARM COLLECTION



All dimensions are given in inches. See the attached "Dimensions Diagram" sheet for more information on the keys used in this chart.

	A	B	C	D	E	F	G	H	I	J	K	L		M	N				O	P	Q	R	S
	OVERALL WIDTH	OVERALL DEPTH	OVERALL HEIGHT	FRAME HEIGHT	SEAT HEIGHT	ARM HEIGHT	FOOT HEIGHT	SEAT HEIGHT (FLOOR TO CUSHION SEAM)	SEAT HEIGHT (FLOOR TO FRAME)	INSIDE SEAT WIDTH	INSIDE SEAT DEPTH W/ BACK CUSHION	INSIDE SEAT DEPTH W/O BACK CUSHION	INSIDE BACK HEIGHT W/ SEAT & BACK CUSHIONS	INSIDE BACK HEIGHT W/ SEAT CUSHION	INSIDE BACK HEIGHT W/O SEAT OR BACK CUSHION	# OF BACK CUSHIONS	# OF SEAT CUSHIONS	ACCENT PILLOWS	ARM HEIGHT W/ SEAT CUSHION	ARM HEIGHT W/O SEAT CUSHION	ARM WIDTH	SLEEPER DEPTH OVERALL	SLEEPER DEPTH INSIDE
6' LUXE ARMLESS SOFA	72	45	32½	27	19¼	-	7½	18¾	12	72	29	35¾	13¾	7¾	15	2	1	0	-	-	-	-	-
7' PETITE ARMLESS SOFA	84	37	32½	27	19¼	-	7½	18¾	12	84	23	28¾	13¾	7¾	15	2	1	0	-	-	-	-	-
7' CLASSIC ARMLESS SOFA	84	41	32½	27	19¼	-	7½	18¾	12	84	25	31¾	13¾	7¾	15	2	1	0	-	-	-	-	-
7' LUXE ARMLESS SOFA	84	45	32½	27	19¼	-	7½	18¾	12	84	29	35¾	13¾	7¾	15	2	1	0	-	-	-	-	-
8' PETITE ARMLESS SOFA	96	37	32½	27	19¼	-	7½	18¾	12	96	23	28¾	13¾	7¾	15	2	1	0	-	-	-	-	-
8' CLASSIC ARMLESS SOFA	96	41	32½	27	19¼	-	7½	18¾	12	96	25	31¾	13¾	7¾	15	2	1	0	-	-	-	-	-
8' LUXE ARMLESS SOFA	96	45	32½	27	19¼	-	7½	18¾	12	96	29	35¾	13¾	7¾	15	2	1	0	-	-	-	-	-
9' PETITE ARMLESS SOFA	108	37	32½	27	19¼	-	7½	18¾	12	108	23	28¾	13¾	7¾	15	2	1	0	-	-	-	-	-
9' CLASSIC ARMLESS SOFA	108	41	32½	27	19¼	-	7½	18¾	12	108	25	31¾	13¾	7¾	15	2	1	0	-	-	-	-	-
9' LUXE ARMLESS SOFA	108	45	32½	27	19¼	-	7½	18¾	12	108	29	35¾	13¾	7¾	15	2	1	0	-	-	-	-	-
10' PETITE ARMLESS SOFA	120	37	32½	27	19¼	-	7½	18¾	12	120	23	28¾	13¾	7¾	15	2	1	0	-	-	-	-	-
10' CLASSIC ARMLESS SOFA	120	41	32½	27	19¼	-	7½	18¾	12	120	25	31¾	13¾	7¾	15	2	1	0	-	-	-	-	-
10' LUXE ARMLESS SOFA	120	45	32½	27	19¼	-	7½	18¾	12	120	29	35¾	13¾	7¾	15	2	1	0	-	-	-	-	-
5' PETITE LEFT-ARM SOFA	60	37	32½	27	19¼	22½	7½	18¾	12	55½	23	28¾	13¾	7¾	15	2	1	0	3¾	10½	4½	-	-

ITALIA TRACK ARM COLLECTION



All dimensions are given in inches. See the attached "Dimensions Diagram" sheet for more information on the keys used in this chart.

	A	B	C	D	E	F	G	H	I	J	K	L		M	N				O	P	Q	R	S
	OVERALL WIDTH	OVERALL DEPTH	OVERALL HEIGHT	FRAME HEIGHT	SEAT HEIGHT	ARM HEIGHT	FOOT HEIGHT	SEAT HEIGHT (FLOOR TO CUSHION SEAM)	SEAT HEIGHT (FLOOR TO FRAME)	INSIDE SEAT WIDTH	INSIDE SEAT DEPTH W/ BACK CUSHION	INSIDE SEAT DEPTH W/O BACK CUSHION	INSIDE BACK HEIGHT W/ SEAT & BACK CUSHIONS	INSIDE BACK HEIGHT W/ SEAT CUSHION	INSIDE BACK HEIGHT W/O SEAT OR BACK CUSHION	# OF BACK CUSHIONS	# OF SEAT CUSHIONS	ACCENT PILLOWS	ARM HEIGHT W/ SEAT CUSHION	ARM HEIGHT W/O SEAT CUSHION	ARM WIDTH	SLEEPER DEPTH OVERALL	SLEEPER DEPTH INSIDE
5' PETITE RIGHT-ARM SOFA	60	37	32½	27	19¼	22½	7½	18¾	12	55½	23	28¾	13¾	7¾	15	2	1	0	3¾	10½	4½	-	-
5' CLASSIC LEFT-ARM SOFA	60	41	32½	27	19¼	22½	7½	18¾	12	54	25	31¾	13¾	7¾	15	2	1	0	3¾	10½	6	-	-
5' CLASSIC RIGHT-ARM SOFA	60	41	32½	27	19¼	22½	7½	18¾	12	54	25	31¾	13¾	7¾	15	2	1	0	3¾	10½	6	-	-
6' PETITE LEFT-ARM SOFA	72	37	32½	27	19¼	22½	7½	18¾	12	67½	23	28¾	13¾	7¾	15	2	1	0	3¾	10½	4½	-	-
6' PETITE RIGHT-ARM SOFA	72	37	32½	27	19¼	22½	7½	18¾	12	67½	23	28¾	13¾	7¾	15	2	1	0	3¾	10½	4½	-	-
6' CLASSIC LEFT-ARM SOFA	72	41	32½	27	19¼	22½	7½	18¾	12	66	25	31¾	13¾	7¾	15	2	1	0	3¾	10½	6	-	-
6' CLASSIC RIGHT-ARM SOFA	72	41	32½	27	19¼	22½	7½	18¾	12	66	25	31¾	13¾	7¾	15	2	1	0	3¾	10½	6	-	-
6' LUXE LEFT-ARM SOFA	72	45	32½	27	19¼	22½	7½	18¾	12	66	29	35¾	13¾	7¾	15	2	1	0	3¾	10½	6	-	-
6' LUXE RIGHT-ARM SOFA	72	45	32½	27	19¼	22½	7½	18¾	12	66	29	35¾	13¾	7¾	15	2	1	0	3¾	10½	6	-	-
7' PETITE LEFT-ARM SOFA	84	37	32½	27	19¼	22½	7½	18¾	12	79½	23	28¾	13¾	7¾	15	2	1	0	3¾	10½	4½	-	-
7' PETITE RIGHT-ARM SOFA	84	37	32½	27	19¼	22½	7½	18¾	12	79½	23	28¾	13¾	7¾	15	2	1	0	3¾	10½	4½	-	-
7' CLASSIC LEFT-ARM SOFA	84	41	32½	27	19¼	22½	7½	18¾	12	78	25	31¾	13¾	7¾	15	2	1	0	3¾	10½	6	-	-
7' CLASSIC RIGHT-ARM SOFA	84	41	32½	27	19¼	22½	7½	18¾	12	78	25	31¾	13¾	7¾	15	2	1	0	3¾	10½	6	-	-
7' LUXE LEFT-ARM SOFA	84	45	32½	27	19¼	22½	7½	18¾	12	78	29	35¾	13¾	7¾	15	2	1	0	3¾	10½	6	-	-

ITALIA TRACK ARM COLLECTION



All dimensions are given in inches. See the attached "Dimensions Diagram" sheet for more information on the keys used in this chart.

	A	B	C	D	E	F	G	H	I	J	K	L		M	N				O	P	Q	R	S
	OVERALL WIDTH	OVERALL DEPTH	OVERALL HEIGHT	FRAME HEIGHT	SEAT HEIGHT	ARM HEIGHT	FOOT HEIGHT	SEAT HEIGHT (FLOOR TO CUSHION SEAM)	SEAT HEIGHT (FLOOR TO FRAME)	INSIDE SEAT WIDTH	INSIDE SEAT DEPTH W/ BACK CUSHION	INSIDE SEAT DEPTH W/O BACK CUSHION	INSIDE BACK HEIGHT W/ SEAT & BACK CUSHIONS	INSIDE BACK HEIGHT W/ SEAT CUSHION	INSIDE BACK HEIGHT W/O SEAT OR BACK CUSHION	# OF BACK CUSHIONS	# OF SEAT CUSHIONS	ACCENT PILLOWS	ARM HEIGHT W/ SEAT CUSHION	ARM HEIGHT W/O SEAT CUSHION	ARM WIDTH	SLEEPER DEPTH OVERALL	SLEEPER DEPTH INSIDE
7' LUXE RIGHT-ARM SOFA	84	45	32½	27	19¼	22½	7½	18¾	12	78	29	35¾	13¾	7¾	15	2	1	0	3¾	10½	6	-	-
8' PETITE LEFT-ARM SOFA	96	37	32½	27	19¼	22½	7½	18¾	12	91½	23	28¾	13¾	7¾	15	2	1	0	3¾	10½	4½	-	-
8' PETITE RIGHT-ARM SOFA	96	37	32½	27	19¼	22½	7½	18¾	12	91½	23	28¾	13¾	7¾	15	2	1	0	3¾	10½	4½	-	-
8' CLASSIC LEFT-ARM SOFA	96	41	32½	27	19¼	22½	7½	18¾	12	90	25	31¾	13¾	7¾	15	2	1	0	3¾	10½	6	-	-
8' CLASSIC RIGHT-ARM SOFA	96	41	32½	27	19¼	22½	7½	18¾	12	90	25	31¾	13¾	7¾	15	2	1	0	3¾	10½	6	-	-
8' LUXE LEFT-ARM SOFA	96	45	32½	27	19¼	22½	7½	18¾	12	90	29	35¾	13¾	7¾	15	2	1	0	3¾	10½	6	-	-
8' LUXE RIGHT-ARM SOFA	96	45	32½	27	19¼	22½	7½	18¾	12	90	29	35¾	13¾	7¾	15	2	1	0	3¾	10½	6	-	-
9' PETITE LEFT-ARM SOFA	108	37	32½	27	19¼	22½	7½	18¾	12	103½	23	28¾	13¾	7¾	15	2	1	0	3¾	10½	4½	-	-
9' PETITE RIGHT-ARM SOFA	108	37	32½	27	19¼	22½	7½	18¾	12	103½	23	28¾	13¾	7¾	15	2	1	0	3¾	10½	4½	-	-
9' CLASSIC LEFT-ARM SOFA	108	41	32½	27	19¼	22½	7½	18¾	12	102	25	31¾	13¾	7¾	15	2	1	0	3¾	10½	6	-	-
9' CLASSIC RIGHT-ARM SOFA	108	41	32½	27	19¼	22½	7½	18¾	12	102	25	31¾	13¾	7¾	15	2	1	0	3¾	10½	6	-	-
9' LUXE LEFT-ARM SOFA	108	45	32½	27	19¼	22½	7½	18¾	12	102	29	35¾	13¾	7¾	15	2	1	0	3¾	10½	6	-	-
9' LUXE RIGHT-ARM SOFA	108	45	32½	27	19¼	22½	7½	18¾	12	102	29	35¾	13¾	7¾	15	2	1	0	3¾	10½	6	-	-
10' PETITE LEFT-ARM SOFA	120	37	32½	27	19¼	22½	7½	18¾	12	115½	23	28¾	13¾	7¾	15	2	1	0	3¾	10½	4½	-	-

ITALIA TRACK ARM COLLECTION



All dimensions are given in inches. See the attached "Dimensions Diagram" sheet for more information on the keys used in this chart.

	A	B	C	D	E	F	G	H	I	J	K	L		M	N				O	P	Q	R	S
	OVERALL WIDTH	OVERALL DEPTH	OVERALL HEIGHT	FRAME HEIGHT	SEAT HEIGHT	ARM HEIGHT	FOOT HEIGHT	SEAT HEIGHT (FLOOR TO CUSHION SEAM)	SEAT HEIGHT (FLOOR TO FRAME)	INSIDE SEAT WIDTH	INSIDE SEAT DEPTH W/ BACK CUSHION	INSIDE SEAT DEPTH W/O BACK CUSHION	INSIDE BACK HEIGHT W/ SEAT & BACK CUSHIONS	INSIDE BACK HEIGHT W/ SEAT CUSHION	INSIDE BACK HEIGHT W/O SEAT OR BACK CUSHION	# OF BACK CUSHIONS	# OF SEAT CUSHIONS	ACCENT PILLOWS	ARM HEIGHT W/ SEAT CUSHION	ARM HEIGHT W/O SEAT CUSHION	ARM WIDTH	SLEEPER DEPTH OVERALL	SLEEPER DEPTH INSIDE
10' PETTITE RIGHT-ARM SOFA	120	37	32½	27	19¾	22½	7½	18¾	12	115½	23	28¾	13¾	7¾	15	2	1	0	3¾	10½	4½	-	-
10' CLASSIC LEFT-ARM SOFA	120	41	32½	27	19¾	22½	7½	18¾	12	114	25	31¾	13¾	7¾	15	2	1	0	3¾	10½	6	-	-
10' CLASSIC RIGHT-ARM SOFA	120	41	32½	27	19¾	22½	7½	18¾	12	114	25	31¾	13¾	7¾	15	2	1	0	3¾	10½	6	-	-
10' LUXE LEFT-ARM SOFA	120	45	32½	27	19¾	22½	7½	18¾	12	114	29	35¾	13¾	7¾	15	2	1	0	3¾	10½	6	-	-
10' LUXE RIGHT-ARM SOFA	120	45	32½	27	19¾	22½	7½	18¾	12	114	29	35¾	13¾	7¾	15	2	1	0	3¾	10½	6	-	-
7' PETTITE LEFT-ARM RETURN SOFA	84	37	32½	27	19¾	22½	7½	18¾	12	63¾	23	28¾	13¾	7¾	15	3	1	0	3¾	10½	4½	-	-
7' PETTITE RIGHT-ARM RETURN SOFA	84	37	32½	27	19¾	22½	7½	18¾	12	63¾	23	28¾	13¾	7¾	15	3	1	0	3¾	10½	4½	-	-
7' CLASSIC LEFT-ARM RETURN SOFA	84	41	32½	27	19¾	22½	7½	18¾	12	62¾	25	31¾	13¾	7¾	15	3	1	0	3¾	10½	6	-	-
7' CLASSIC RIGHT-ARM RETURN SOFA	84	41	32½	27	19¾	22½	7½	18¾	12	62¾	25	31¾	13¾	7¾	15	3	1	0	3¾	10½	6	-	-
7' LUXE LEFT-ARM RETURN SOFA	84	45	32½	27	19¾	22½	7½	18¾	12	62¾	29	35¾	13¾	7¾	15	3	1	0	3¾	10½	6	-	-
7' LUXE RIGHT-ARM RETURN SOFA	84	45	32½	27	19¾	22½	7½	18¾	12	62¾	29	35¾	13¾	7¾	15	3	1	0	3¾	10½	6	-	-
8' PETTITE LEFT-ARM RETURN SOFA	96	37	32½	27	19¾	22½	7½	18¾	12	75¾	23	28¾	13¾	7¾	15	3	1	0	3¾	10½	4½	-	-
8' PETTITE RIGHT-ARM RETURN SOFA	96	37	32½	27	19¾	22½	7½	18¾	12	75¾	23	28¾	13¾	7¾	15	3	1	0	3¾	10½	4½	-	-
8' CLASSIC LEFT-ARM RETURN SOFA	96	41	32½	27	19¾	22½	7½	18¾	12	74¾	25	31¾	13¾	7¾	15	3	1	0	3¾	10½	6	-	-

ITALIA TRACK ARM COLLECTION



All dimensions are given in inches. See the attached "Dimensions Diagram" sheet for more information on the keys used in this chart.

	OVERALL WIDTH A	OVERALL DEPTH B	OVERALL HEIGHT C	FRAME HEIGHT D	SEAT HEIGHT E	ARM HEIGHT F	FOOT HEIGHT G	SEAT HEIGHT (FLOOR TO CUSHION SEAM) H	SEAT HEIGHT (FLOOR TO FRAME) I	INSIDE SEAT WIDTH J	INSIDE SEAT DEPTH W/ BACK CUSHION K	INSIDE SEAT DEPTH W/O BACK CUSHION L	INSIDE BACK HEIGHT W/ SEAT & BACK CUSHIONS M	INSIDE BACK HEIGHT W/ SEAT CUSHION N	# OF BACK CUSHIONS	# OF SEAT CUSHIONS	ACCENT PILLOWS	ARM HEIGHT W/ SEAT CUSHION O	ARM HEIGHT W/O SEAT CUSHION P	ARM WIDTH Q	SLEEPER DEPTH OVERALL R	SLEEPER DEPTH INSIDE S	
8' CLASSIC RIGHT-ARM RETURN SOFA	96	41	32½	27	19¾	22½	7½	18¾	12	74¾	25	31¾	13¾	7¾	15	3	1	0	3¾	10½	6	-	-
8' LUXE LEFT-ARM RETURN SOFA	96	45	32½	27	19¾	22½	7½	18¾	12	74¾	29	35¾	13¾	7¾	15	3	1	0	3¾	10½	6	-	-
8' LUXE RIGHT-ARM RETURN SOFA	96	45	32½	27	19¾	22½	7½	18¾	12	74¾	29	35¾	13¾	7¾	15	3	1	0	3¾	10½	6	-	-
9' PETITE LEFT-ARM RETURN SOFA	108	37	32½	27	19¾	22½	7½	18¾	12	87¾	23	28¾	13¾	7¾	15	3	1	0	3¾	10½	4½	-	-
9' PETITE RIGHT-ARM RETURN SOFA	108	37	32½	27	19¾	22½	7½	18¾	12	87¾	23	28¾	13¾	7¾	15	3	1	0	3¾	10½	4½	-	-
9' CLASSIC LEFT-ARM RETURN SOFA	108	41	32½	27	19¾	22½	7½	18¾	12	86¾	25	31¾	13¾	7¾	15	3	1	0	3¾	10½	6	-	-
9' CLASSIC RIGHT-ARM RETURN SOFA	108	41	32½	27	19¾	22½	7½	18¾	12	86¾	25	31¾	13¾	7¾	15	3	1	0	3¾	10½	6	-	-
9' LUXE LEFT-ARM RETURN SOFA	108	45	32½	27	19¾	22½	7½	18¾	12	86¾	29	35¾	13¾	7¾	15	3	1	0	3¾	10½	6	-	-
9' LUXE RIGHT-ARM RETURN SOFA	108	45	32½	27	19¾	22½	7½	18¾	12	86¾	29	35¾	13¾	7¾	15	3	1	0	3¾	10½	6	-	-
10' PETITE LEFT-ARM RETURN SOFA	120	37	32½	27	19¾	22½	7½	18¾	12	99¾	23	28¾	13¾	7¾	15	3	1	0	3¾	10½	4½	-	-
10' PETITE RIGHT-ARM RETURN SOFA	120	37	32½	27	19¾	22½	7½	18¾	12	99¾	23	28¾	13¾	7¾	15	3	1	0	3¾	10½	4½	-	-
10' CLASSIC LEFT-ARM RETURN SOFA	120	41	32½	27	19¾	22½	7½	18¾	12	98¾	25	31¾	13¾	7¾	15	3	1	0	3¾	10½	6	-	-
10' CLASSIC RIGHT-ARM RETURN SOFA	120	41	32½	27	19¾	22½	7½	18¾	12	98¾	25	31¾	13¾	7¾	15	3	1	0	3¾	10½	6	-	-
10' LUXE LEFT-ARM RETURN SOFA	120	45	32½	27	19¾	22½	7½	18¾	12	98¾	29	35¾	13¾	7¾	15	3	1	0	3¾	10½	6	-	-

ITALIA TRACK ARM COLLECTION



All dimensions are given in inches. See the attached "Dimensions Diagram" sheet for more information on the keys used in this chart.

	A	B	C	D	E	F	G	H	I	J	K	L		M	N				O	P	Q	R	S
	OVERALL WIDTH	OVERALL DEPTH	OVERALL HEIGHT	FRAME HEIGHT	SEAT HEIGHT	ARM HEIGHT	FOOT HEIGHT	SEAT HEIGHT (FLOOR TO CUSHION SEAM)	SEAT HEIGHT (FLOOR TO FRAME)	INSIDE SEAT WIDTH	INSIDE SEAT DEPTH W/ BACK CUSHION	INSIDE SEAT DEPTH W/O BACK CUSHION	INSIDE BACK HEIGHT W/ SEAT & BACK CUSHIONS	INSIDE BACK HEIGHT W/ SEAT CUSHION	INSIDE BACK HEIGHT W/O SEAT OR BACK CUSHION	# OF BACK CUSHIONS	# OF SEAT CUSHIONS	ACCENT PILLOWS	ARM HEIGHT W/ SEAT CUSHION	ARM HEIGHT W/O SEAT CUSHION	ARM WIDTH	SLEEPER DEPTH OVERALL	SLEEPER DEPTH INSIDE
10' LUXE RIGHT-ARM RETURN SOFA	120	45	32½	27	19¾	22½	7½	18¾	12	98¾	29	35¾	13¾	7¾	15	3	1	0	3¾	10½	6	-	-
PETITE LEFT-ARM CHAISE	41	64	32½	27	19¾	22½	7½	18¾	12	36½	50	55¾	13¾	7¾	15	1	1	0	3¾	10½	4½	-	-
PETITE RIGHT-ARM CHAISE	41	64	32½	27	19¾	22½	7½	18¾	12	36½	50	55¾	13¾	7¾	15	1	1	0	3¾	10½	4½	-	-
CLASSIC LEFT-ARM CHAISE	41	68	32½	27	19¾	22½	7½	18¾	12	35	52	58¾	13¾	7¾	15	1	1	0	3¾	10½	6	-	-
CLASSIC RIGHT-ARM CHAISE	41	68	32½	27	19¾	22½	7½	18¾	12	35	52	58¾	13¾	7¾	15	1	1	0	3¾	10½	6	-	-
LUXE LEFT-ARM CHAISE	45	72	32½	27	19¾	22½	7½	18¾	12	39	56	62¾	13¾	7¾	15	1	1	0	3¾	10½	6	-	-
LUXE RIGHT-ARM CHAISE	45	72	32½	27	19¾	22½	7½	18¾	12	39	56	62¾	13¾	7¾	15	1	1	0	3¾	10½	6	-	-
PETITE END-OF-SECTIONAL OTTOMAN	37	37	18½	18½	18½	-	7½	17	12	37	-	-	-	-	-	0	1	-	-	-	-	-	-
CLASSIC END-OF-SECTIONAL OTTOMAN	41	41	18½	18½	18½	-	7½	17	12	41	-	-	-	-	-	0	1	-	-	-	-	-	-
LUXE END-OF-SECTIONAL OTTOMAN	45	45	18½	18½	18½	-	7½	17	12	45	-	-	-	-	-	0	1	-	-	-	-	-	-

UPHOLSTERY DIMENSIONS DIAGRAM

See the "Dimensions Sheet" for the measurements that correspond with the letters below.

RH

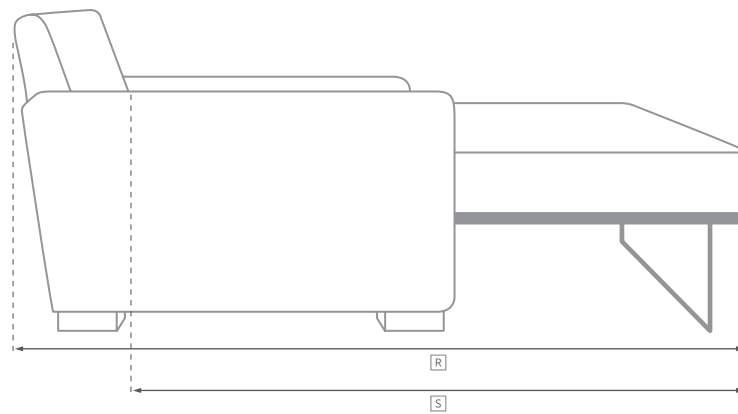
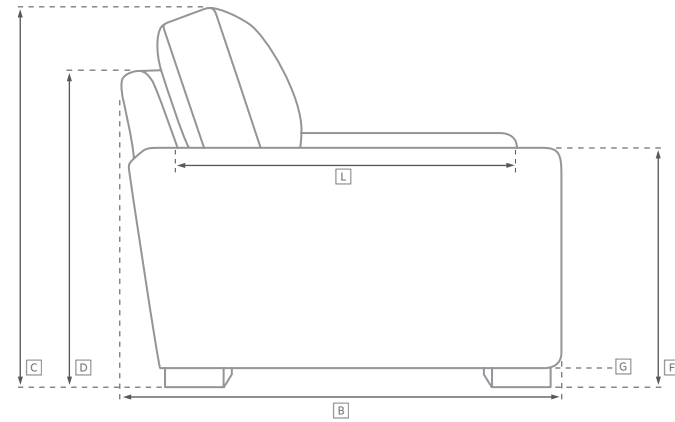
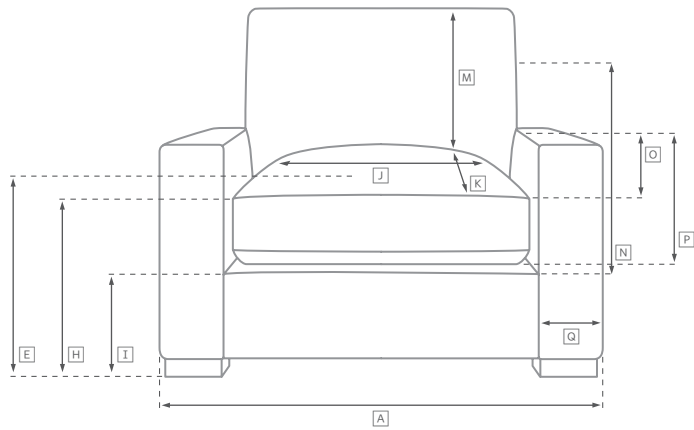

SOFA CHAISE SECTIONAL

Available in left and right-arm configurations.

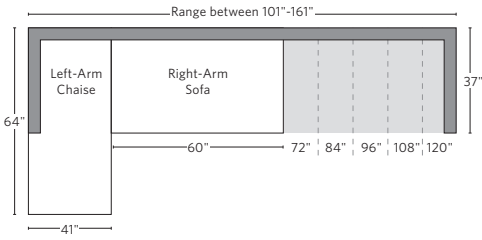

U-CHAISE SECTIONAL

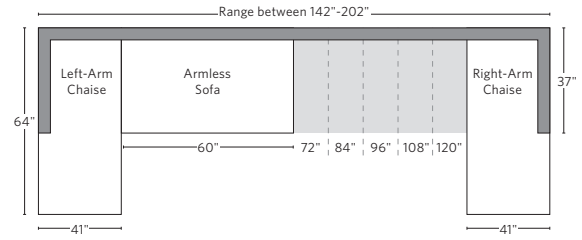

L-SECTIONAL

Available in left and right-arm configurations.

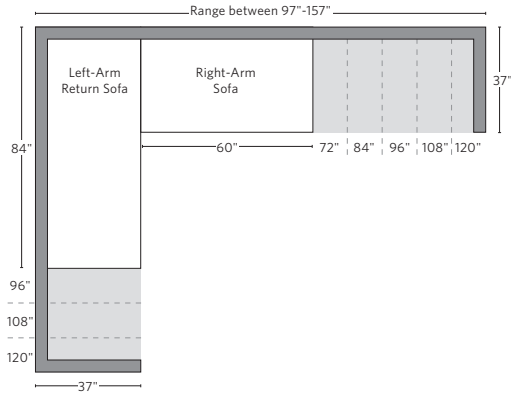

U-SOFA CHAISE SECTIONAL

Available in left and right-arm configurations.

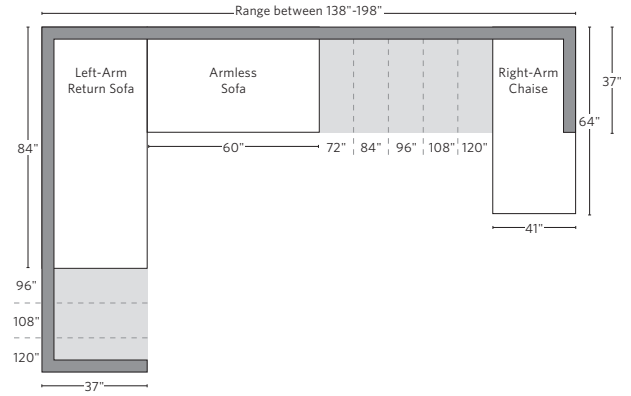

U-SOFA SECTIONAL

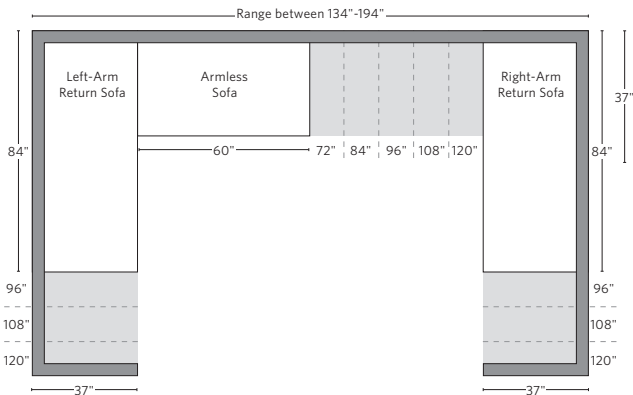

Multiple length options available.

SOFA CHAISE SECTIONAL

Available in left and right-arm configurations.

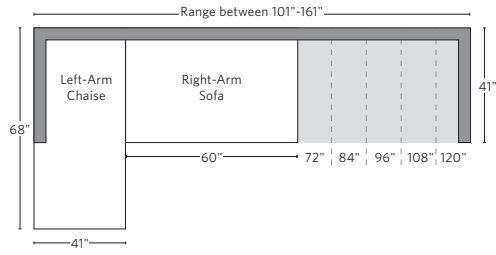

U-CHAISE SECTIONAL

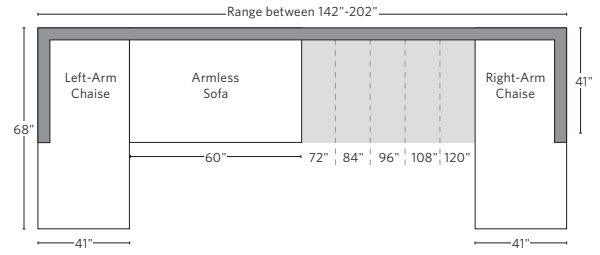

L-SECTIONAL

Available in left and right-arm configurations.

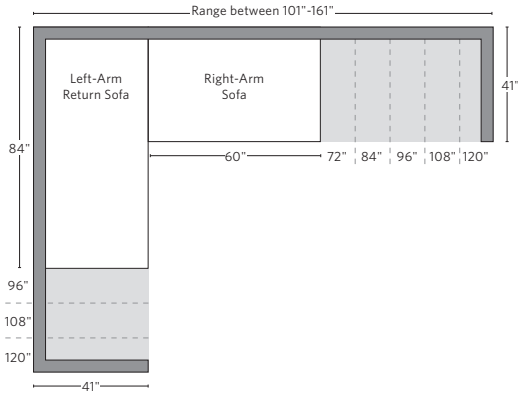

U-SOFA CHAISE SECTIONAL

Available in left and right-arm configurations.

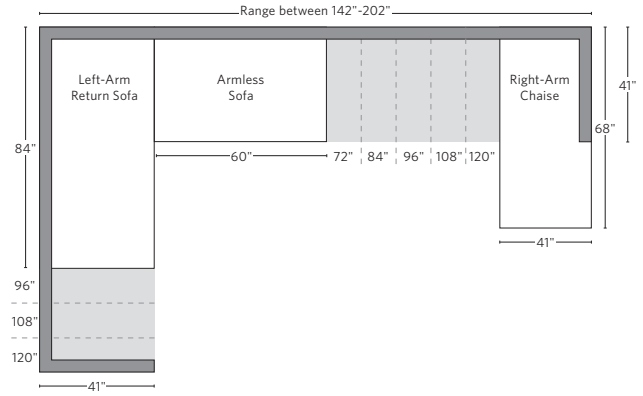

U-SOFA SECTIONAL

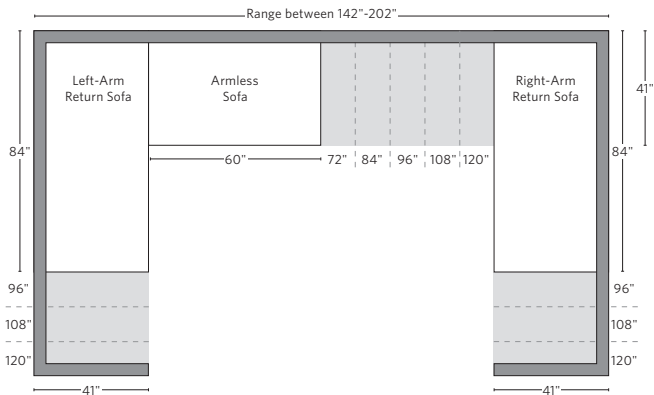

Multiple length options available.

SOFA CHAISE SECTIONAL

Available in left and right-arm configurations.

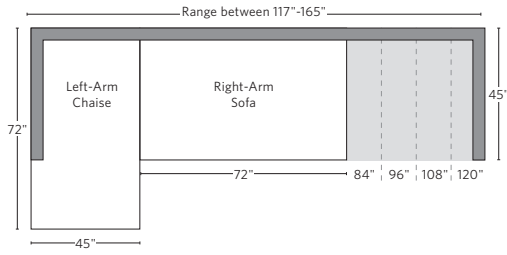

U-CHAISE SECTIONAL

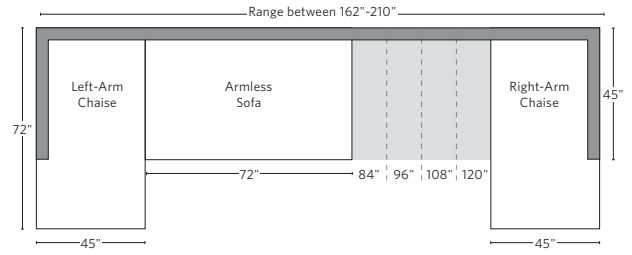

L-SECTIONAL

Available in left and right-arm configurations.

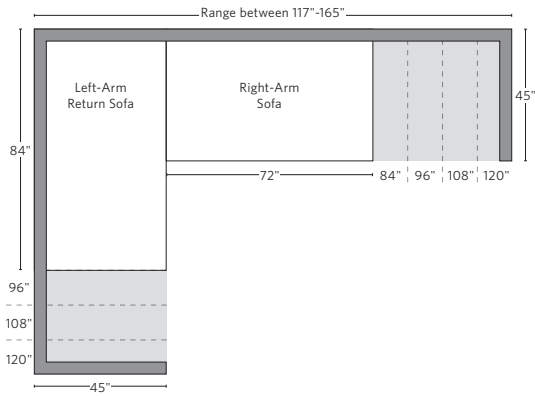

U-SOFA CHAISE SECTIONAL

Available in left and right-arm configurations.

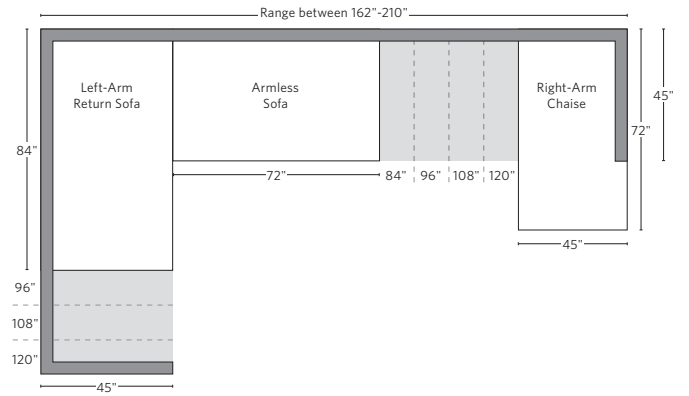

U-SOFA SECTIONAL

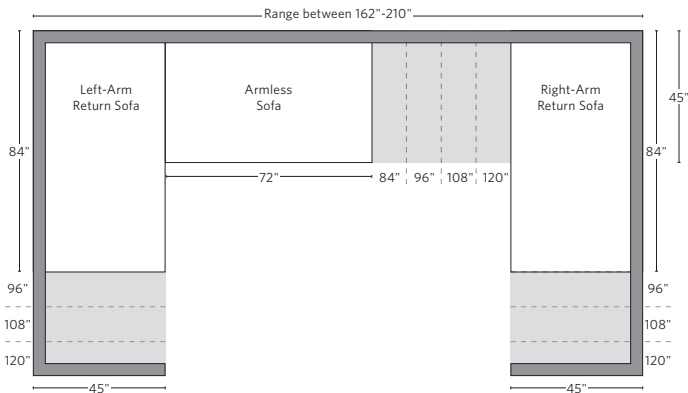

Multiple length options available.