

RESTORATION HARDWARE

EASTON UPHOLSTERED COLLECTION



6' Classic Sofa
6' Luxe Sofa
7' Classic Sofa*
7' Luxe Sofa*
8' Classic Sofa
8' Luxe Sofa*
9' Classic Sofa
9' Luxe Sofa
Classic Chair
Luxe Chair
Ottoman
107" Left-Arm Sofa
Chaise Sectional
107" Right-Arm Sofa
Chaise Sectional

72"W x 44"D x 34"H
72"W x 48"D x 34"H
84"W x 44"D x 34"H
84"W x 48"D x 34"H
96"W x 44"D x 34"H
96"W x 48"D x 34"H
108"W x 44"D x 34"H
108"W x 48"D x 34"H
35"W x 44"D x 34"H
35"W x 48"D x 34"H
27"W x 23"D x 18"H
107"W x 70"D x 34"H

107"W x 70"D x 34"H

36" Left-Arm Chaise
36" Right-Arm Chaise
71" Left-Arm Sofa
71" Right-Arm Sofa
101" Left-Arm Sofa
101" Right-Arm Sofa
115" Corner Sectional
148" Left-Arm L-Sectional
148" Right-Arm L-Sectional
137" U-Chaise Sectional
153" U-Sofa Sectional
Armless Chair
Armless Sofa
112" Corner Sofa

36"W x 70"D x 34"H
36"W x 70"D x 34"H
71"W x 44"D x 34"H
71"W x 44"D x 34"H
101"W x 44"D x 34"H
101"W x 44"D x 34"H
115"W x 112"D x 34"H
148"W x 112"D x 34"H
148"W x 112"D x 34"H
137"W x 70"D x 34"H
153"W x 112"D x 34"H
33"W x 44"D x 34"H
65"W x 44"D x 34"H
112"W x 44"D x 34"H

Unlimited Furniture Delivery Starting at \$95. See a store associate or our website for details.

Available in 4 stain-resistant fabrics and 8 hues, and 7 premium leathers. *Stocked in sand Belgian Linen (shown), with standard or down-blend fill; 1-2 week delivery. All other colors and fabrics are custom order; 6-8 week delivery. See our website for delivery to Canada, pricing and additional views.

FEATURES

The redesigned Easton Upholstered Collection retains the original's modern, sophisticated shape with its signature tailored lines and loose cushions, but now features distressed brass nailheads and even more sumptuous comfort.

- Sofas and chair available in 2 depths
- Built of kiln-dried hardwood
- 8-way hand-tied springs
- Double-doweled frames reinforced with corner blocks
- Sink-in comfort courtesy of deep seats and spacious proportions
- Brass nailhead trim is distressed and richly antiqued
- Exposed block feet finished in weathered oak
- Box-edged, welted back pillows

- Loose back and seat cushions
- Choose standard fill (polyfiber wrapped around 4½"-foam core) or down-blend fill (feather and down wrapped around a 4½"-foam core)
- Coordinating back cushions are all polyfiber for standard fill, or a blend of feathers, down and polyfiber for down-blend fill

FABRIC CARE

Dust or vacuum regularly to help keep fabric looking new. Avoid direct sunlight and heat to prevent premature fading. Dab spills immediately with soft white cloth dampened with distilled water. Do not use tap water or detergents to clean. Do not wash or dry clean cushions or pillowcases separately as it could cause a slight variation in color. Professional in-home upholstery cleaning is recommended.

SWATCHES

Complimentary swatches available online, in stores or by calling 800.816.0901.

RESTORATION HARDWARE

MEASURING FURNITURE FOR DELIVERY

Before purchasing any furniture, it's important to ensure it can fit through all the entryways, elevators and stairways of your home. Follow these steps to ensure efficient delivery and avoid returns.

- Determine the best pathway from outside your home to the room where the new item will be placed.
- Make sure all access points are unobstructed and wide enough for the desired item.
- Measure the heights and widths of all entryways, including all stairways and hallways, both inside and outside your home (see 1).
- Measure the interior widths, depths and heights of all elevator doors to be used for delivery.
- Measure your entry clearance - the distance from the wall through the doorway to the opposite wall (see 2).
- Factor in all corners, ceiling height, stairways (heights, widths, angles, bannisters), and low hanging fixtures. Also account for any architectural details (see 3).
- Compare your measurements from above to the item's "minimum clearance" measurement online.
- To ensure successful delivery, the item's minimum clearance measurement must not exceed the height or width of any of the entryways (elevators and stairways included) to be used for delivery.
- Note that the furniture measurements we provide reflect overall dimensions, and overhangs, angles and outward curves will be included (see 4).

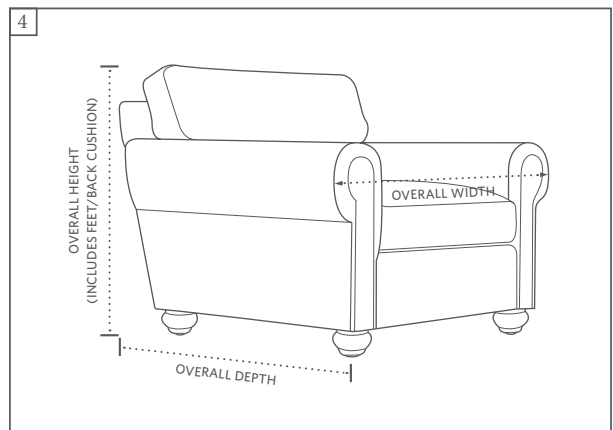
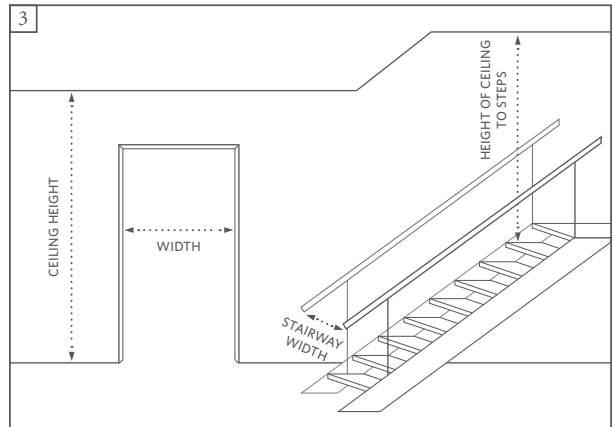
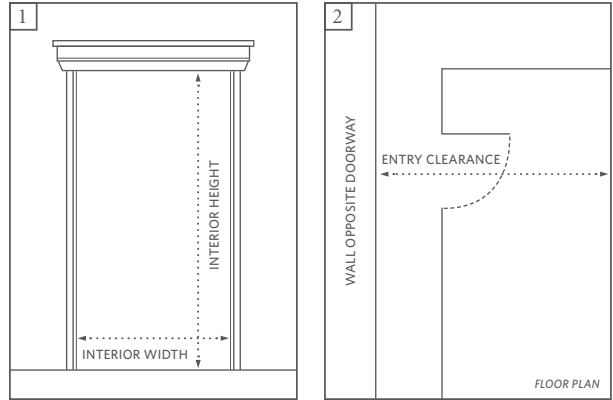

🔗 Unlimited Furniture Delivery starting at \$95. See our website or ask an associate for more details.

At Restoration Hardware, we take pride in the exceptional quality and craftsmanship of our furniture. Our attention to detail in design, material and construction is unyielding. And so is our commitment to customer satisfaction.

We carefully inspect each furniture item prior to shipment, and also require your inspection and signature upon delivery. Should you discover a defect in your furniture, however, please contact us at 800.910.9836 immediately. Furniture that is refused because it does not fit through an entryway will be refunded in merchandise or store credit only. Visit restorationhardware.com for more information on returns.

Please call Customer Service at 800.910.9836 with any questions you may have.

RESTORATION HARDWARE

SECTIONALS GUIDE - HOME

SECTIONAL COMPONENTS

Our sectionals are composed of the following pieces: an “armless” chair or sofa; a “left-arm” chaise, sofa or corner sofa; and/or a “right-arm” chaise, sofa or corner sofa. Each component is named by the position of the arm as you face the piece:



Armless Chair

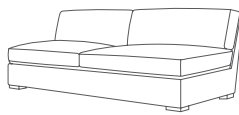

Armless Sofa



Left-Arm Chaise

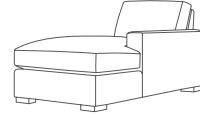

Right-Arm Chaise

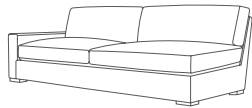

Left-Arm Sofa

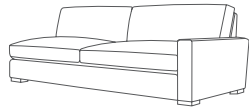

Right-Arm Sofa

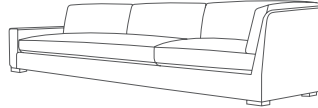

Left-Arm Corner Sofa

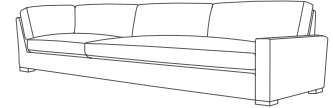

Right-Arm Corner Sofa

SECTIONAL SET CONFIGURATIONS

Restoration Hardware Home sectionals are sold as complete sets*. As with individual components (see above), sectionals are named by the position of the arm on the identifying piece, as you face the set:



Right-Arm Sofa Chaise Sectional

Consists of (L to R):

1 Left-Arm Sofa and 1 Right-Arm Chaise

Left-Arm Sofa Chaise Sectional also available



U-Chaise Sectional

Consists of (L to R):

1 Left-Arm Chaise, 1 Armless Sofa
and 1 Right-Arm Chaise

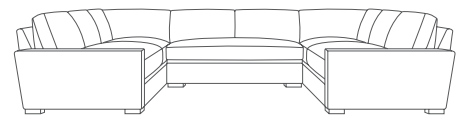

U-Sofa Sectional

Consists of (L to R):

1 Left-Arm Corner Sofa, 1 Armless Sofa
and 1 Right-Arm Corner Sofa

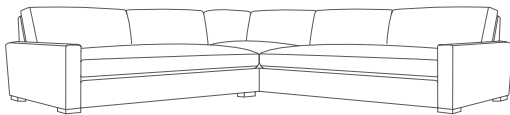

Corner Sectional

Consists of (L to R):

1 Left-Arm Sofa and 1 Right-Arm Corner Sofa



Right-Arm L-Sectional

Consists of (L to R):

1 Left-Arm Sofa, 1 Armless Chair and 1 Right-Arm Corner Sofa

Left-Arm L-Sectional also available

* For Restoration Hardware Outdoor & Garden sectionals, please visit restorationhardware.com or contact a store or customer service associate.