

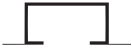





RESTORATION HARDWARE

ACHANTHUS LEAF CHANDELIER

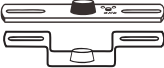
PARTS:			
ITEM	DIAGRAM	DESCRIPTION	QTY.
(A)		OUTLET BOX	1
(B)		THREADED TUBE	2
(C)		CROSS BAR S/2	2
(D)		MOUNTING SCREWS	2
(E)		CANOPY	1
(F)		CHAIN NUT	1
(G)		CHAIN	1

Mounting Assembly Instruction

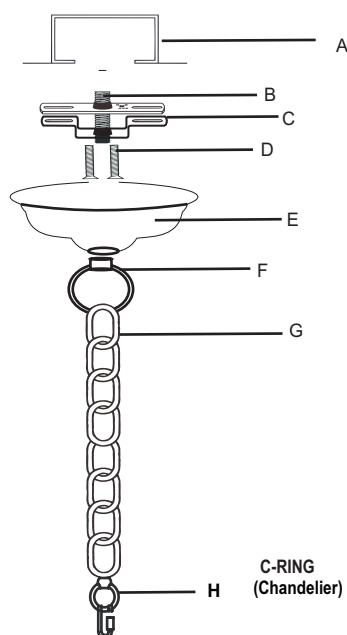

1. Attach the chain to fixture body using the C-Ring.

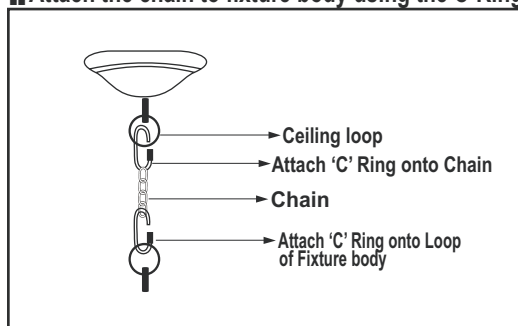

IMPORTANT SAFETY INSTRUCTION:

* These instruction are provided for your safety. It is very important that they are read completely before beginning the installation of your fixture.

TURN OFF ELECTRICITY AT MAIN CIRCUIT BREAKER PANEL BEFORE BEGINNING INSTALLATION.

THIS DIRECT WIRE FIXTURE MUST BE INSTALLED BY A CERTIFIED AND LICENCED ELECTRICIAN. Customer should not attempt to install.

WARNINGS:

DUE TO WEIGHT OF THIS ITEM, THE MINIMUM RATING ON YOUR CEILING OUTLET BOX MUST BE 100 LBS. FOR FIXTURE. IT'S IMPERATIVE THAT YOU FOLLOW THE MANUFACTURERS INSTRUCTIONS FOR CEILING OUTLET BOX INSTALLATION.

* IF ANY SPECIAL CONTROL DEVICES ARE USED WITH FIXTURE, FOLLOW THE INSTRUCTION CAREFULLY TO ASSURE FULL COMPLIANCE WITH N.E.C. REQUIREMENT. IF THERE ARE ANY QUESTIONS, CONTACT A LICENCED ELECTRICAL CONTRACTOR.*

INSTRUCTIONS:

1. Measure desire drop for fixture to hang from ceiling. Remove any unnecessary links from chain (J) using a chain-break tool (not included).
2. Attach cross bar (C) with threaded tube (B) to ceiling outlet box using mounting screw (D). NOTE: DUE TO THE WEIGHT OF THIS ITEM, THE MINIMUM RATING ON YOUR CEILING OUTLET BOX MUST BE 100 LBS. FOR FIXTURES.
3. Slide canopy (E) up and hold flush against ceiling and screw the chain nut onto the threading tube to hang the fixture to ceiling.
4. Pull wires from ceiling outlet box make proper electrical connection s described in step 5-7.
5. Attach ground wire from fixture to ground wire from outlet box. Fasten wirse together and tightly wrap connection with electrical tape
6. Attach hot wire from fixture to hot wire from outlet box .and tightly wrap connection with electrical tape.
7. Attach neutral wire from fixture to neutral wire from outlet box. and tightly wrap connection with electrical tape.

CARE INSTRUCTION:

To clean, use a soft cloth only. DO NOT use any chemical or abrasive cleaner.