

PARTS ENCLOSED

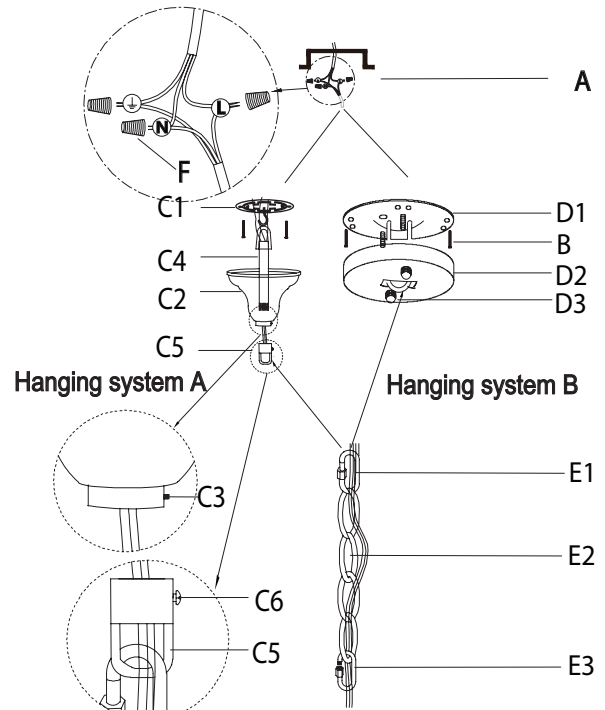





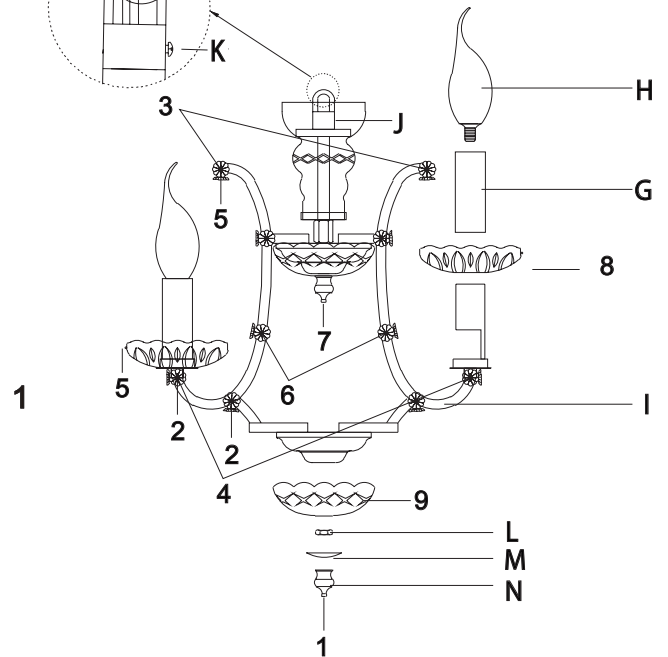

- (A) Junction Box, 22.7kg/50lbs. MIN. FIXTURE RATED (not included)
- (B) Mounting Screws (4; not included)
- (C1) Ceiling Plate A (1)
- (C2) Canopy A (1)
- (C3) Bolt (1)
- (C4) Collar (1)
- (C5) Hang Straight (1)
- (D1) Ceiling Plate B (1)
- (D2) Canopy B (1)
- (D3) Bolt (1)
- (E1) 6mm Quick Link (1)
- (E2) 6mm Chain (1)
- (E3) 6mm Quick Link (1)
- (F) Wire Nuts (3)
- (G) Candle Sleeves (4)
- (H) Bulbs +Spares (4+1)
- (I) Body (1)
- (J) Hang Straight (1)
- (K) Bolt (1)
- (L) Nut (1)
- (M) Round Lid (1)
- (N) Metal Knob (1)



PRODUCT DESCRIPTION

General material: Chinese Crystal & Iron
 Height: 17.32in (44.5cm)
 Diameter: 13.78in (35.0cm)
 Weight: 9.26lbs (4.2kgkg)
 Grounded / Hardwired



1 14mmX1pc	2 14mmX1pc	3 14mmX7pcs	4 14mmX9pcs	5 14mmX1pc	6 14mmX4pcs	7 14mmX1pc	8 4PCS 9
							 
D40mm 1PC	50X38mm 8PCS	50X38mm 4PCS	50X38mm 4PCS	50X38mm 20PCS	4PCS	D30mm 1PC	1PC

RH

19TH C. ROCOCO IRON & CRYSTAL ROUND CHANDELIER 14"

PROFESSIONAL INSTALLATION REQUIRED

IMPORTANT SAFETY INSTRUCTIONS

1. Use an authorized and certified electrician for consultation and installation.
2. This fixture has been rated for four (4) 25-watt maximum E12 bulbs.
3. To avoid the risk of fire, do not exceed the recommended wattage.
4. The ceiling must have at least the capacity of 5 times the weight of the ceiling light. For this light, at least a ceiling capacity of 46.29lbs (21kg) is required.
5. The manufacturer and distributor accept no liability for incorrect installation.
6. For indoor use only.
7. Keep away from children.

WARNINGS

1. Turn off electricity supply at main circuit panel before installing. Do not connect electricity supply until your light is fully assembled and installed.
2. All wires are connected. Do not remove the ceiling light from its packaging by pulling on the power cord, as a bad connection may result.
3. To reduce the risk of fire, electrical shock, or personal injury, always turn off the ceiling light and allow it to cool prior to replacing lightbulbs. Do not touch bulbs when fixture is turned on or look directly at lightbulbs. Keep flammable materials away from lightbulb.
4. Deviation from instructions may result in a risk of fire or electric shock.

THIS PRODUCT IS NOT A TOY AND HAS NO PLAY VALUE.

ASSEMBLY & INSTRUCTIONS

1. Carefully remove all parts from the box and remove all plastic covering.
2. Turn OFF power to junction box where the ceiling light will be installed.
3. The implementation of hanging system depends on whether the ceiling is vaulted or level.
 - 3.1. Hanging system A is for level ceiling, which include ceiling plate A (C1), canopy A (C2), collar (C4), and hang straight (C5). Loosen the bolt of hang straight (C3) and remove the collar (C4) from the hang straight (C5) by unscrewing it. Then insert collar (C4) into canopy A (C2) and re-attach collar (C4) to hang straight (C5). Tighten the bolt (C6) of the hang straight (C5).
 - 3.2. Hanging system B is for sloped ceiling, which include ceiling plate B (D1), canopy B (D2), and bolt nut (D3). Loosen the bolt nut (D3) of canopy (D2) and remove the ceiling plate B (D1) from the canopy.
4. Unlock the quick link (E3) on the opposite end of the chain (E2) and attach to the hang straight (H) on the glass bottle (M).
5. Attach the ceiling plate (C1 or D1) to the ceiling with mounting screws (B).

ASSEMBLY & INSTRUCTIONS CONT.

6. Hanging system A: Attach the end of the collar (C4) to the ceiling plate (C2). Unlock the quick link at the top of the chain to attach the ceiling plate A.
Hanging system B: Attach the canopy B (D2) to the ceiling plate B (D1). Unlock the quick link at the top of the chain to attach the ceiling plate B.
7. Connect the ground wire from the fixture to the ground junction box wire (A) (usually the green or bare wire) and wrap the connection with electrical tape. Connect the hot wire to the hot junction box wire (A) (usually black or smooth) with a plastic wire nut (F) and wrap the connection with electrical tape. Connect the neutral wire to the neutral junction box wire (A) (usually white or ribbed) with a plastic wire nut (F) and wrap the connection with electrical tape.
8. Move the canopy (C1 or D1) up to the ceiling, then fasten the bolt (C3) or bolt nut (D3).
9. Loosen metal knob (O) and detach round lid (N) from body (I), then loosen the nut (M) and detach from the body (I).
10. Fix glass dish (9) onto body (I), and secure with nut (L).
11. Re-attach round lid (M) to body (I) and secure with metal knob (N).
12. Position glass dishes (8) and candle sleeves (G) and hang the crystals as per drawing on left.
13. Fasten lightbulbs (H) to the lampholders.
14. Restore power to the junction box and test ceiling light fixture.

CARE INSTRUCTIONS

1. Make sure that power is turned off and bulbs have cooled before handling.
2. Wipe clean with a dry cloth / mild soapy solution. Do not use corrosive cleaners.
3. The cable / cord of this ceiling light cannot be replaced; if the cable is damaged, do not use the light.

ENVIRONMENT

Special waste handling may be required. Please contact your local authorities for more information.