









RESTORATION HARDWARE

CRYSTAL HALO CHANDELIER -41"

PARTS ENCLOSED

ITEMS	DIAGRAM	DESCRIPTION	QTY.
(A)		Junction Box(Not included) 50LB. MIN.FIXTURE RATED	1
(B)		Mounting Screws (Not included)	3
(C)		Wire Nut	3
(D1)		Ceiling Plate	1
(D2)		Canopy	1
(D3)		Bolt	3
(D4)		Nut	3
(D5)		Body	1
(E)		Bulb+Spares	12+4

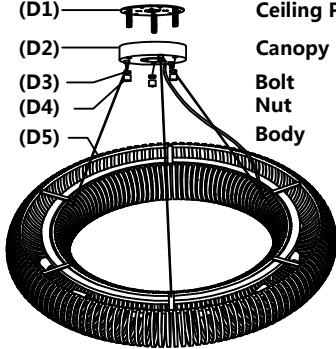

IMPORTANT SAFETY INSTRUCTIONS:

1. Use an authorized and certified electrician for consultation and installation. Electrician must be familiar with commercial-type applications of very heavy chandeliers.
2. The Screws need to be screwed into a solid support structure inside the ceiling, which would require professional.
3. This fixture has been rated for 12 x 25-watt maximum E12 standard bulb.
4. To avoid the risk of fire, do not exceed the recommended wattage.
5. The ceiling must have at least the capacity of 5 times the weight of the ceiling light. For this light at least a ceiling capacity of 145kg(319.73lb) is required.
6. The manufacturer and distributor accepts no liability for incorrect installation.
7. For indoor use only.
8. Keep away from children.

Warnings:

1. Turn-off electricity supply at main circuit panel before installing. Do not connect electricity supply until your ceiling light is fully assembled and installed.
2. All wires are connected. Do not remove the ceiling light from its packaging by pulling on the power cord, as a bad connection may result.
3. To reduce the risk of fire, electrical shock, or personal injury, always turn off the ceiling light and allow it to cool prior to replacing light bulb. Do not touch bulb when fixture is turned on or look directly at light bulb. Keep flammable materials away from light bulb.
4. Deviation from instructions may result in a risk of fire or electric shock.

PRODUCT DESCRIPTION:

General material: Glass & Iron
 Height: 16.5 cm(6.50in)
 Diameter: 102.5 cm(40.35in)
 Weight: 33 kg(72.75lb)
 Grounded / Hardwired

TO ASSEMBLE:

1. Carefully remove all parts from the box and remove all plastic covering.
2. Turn OFF power to the junction box where the ceiling light will be installed.
3. Loosen the bolt and nut (D3 and D4) and remove the ceiling plate (D1) from the ceiling box.
4. Attach the ceiling plate (D1) to ceiling with mounting screws (B).
5. Connect the ground wire from the fixture to the ground junction box wire (Usually the green or bare wire) with a wire nut (C) and wrap the connection with electrical tape. Connect the hot wire to the hot junction box wire (Usually black or smooth) with a plastic wire nut (C) and wrap the connection with electrical tape. Connect the neutral wire to the neutral junction box wire (Usually white or ribbed) with a plastic wire nut (C) and wrap the connection with electrical tape.
6. Move canopy (D2) up to the ceiling, then fasten the bolt&nut (D3 and D4).
7. Press and loosen the height adjustable wire locking device (D6) to adjust the height of light and level it.
8. Fasten lightbulbs (E) to the lampholders inside the body (D5).
9. Restore power to the junction box and test ceiling light fixture.

CARE INSTRUCTIONS:

1. Make sure that the power is turned off and bulb has cooled before handling.
2. Wipe clean with a dry cloth / mild soapy solution. Do not use corrosive cleaners.
3. The cable/cord of this ceiling light cannot be replaced: If the cable is damaged, do not use the light.

ENVIRONMENT:

Special waste handling may be required. Please contact your local authorities for more information.

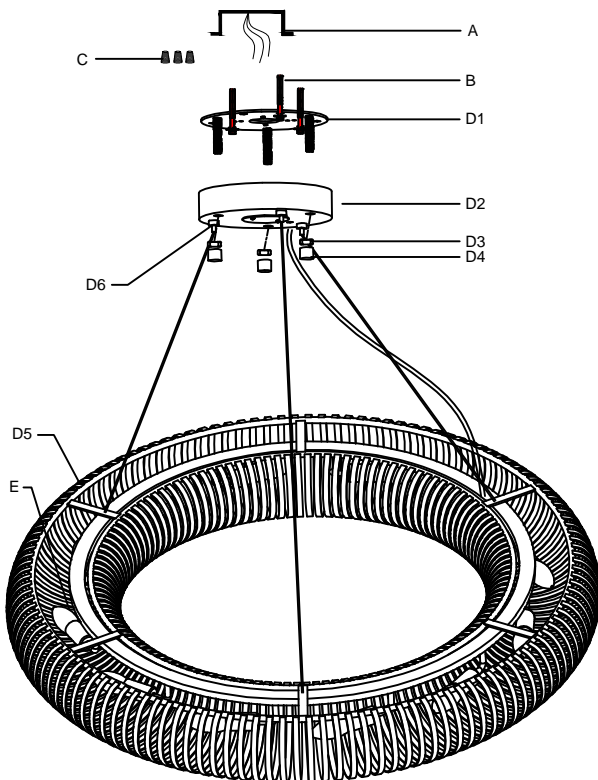

CEILING SAFETY CABLE ASSEMBLY

1. Remove the Nut locker A & B by loosening the Set Screw from the Ceiling safety cable before installation.
2. Insert the Ceiling safety cable through the Nut lockers as the drawing shows.
3. Fasten the Nut locker A with Set Screw by Small Allen Key.
4. Fasten the Nut locker B with Set Screw by Small Allen Key.

