

RH

ST. JAMES 96" & 108" MARBLE DINING TABLE INSTRUCTIONS

Thank you for choosing this quality product. Be sure to check all packaging materials carefully for small parts that may have become loose during shipment and place all parts on a non-abrasive surface.

IMPORTANT

These table parts can be cumbersome and heavy; the assistance of four or more people is recommended in order to prevent personal injury and ensure the table parts are not damaged during the assembly process.

PARTS INCLUDED

- A [1] MARBLE TOP TABLE
- B [2] BASE
- C [2] TOP STRETCHER
- D [1] BOTTOM STRETCHER

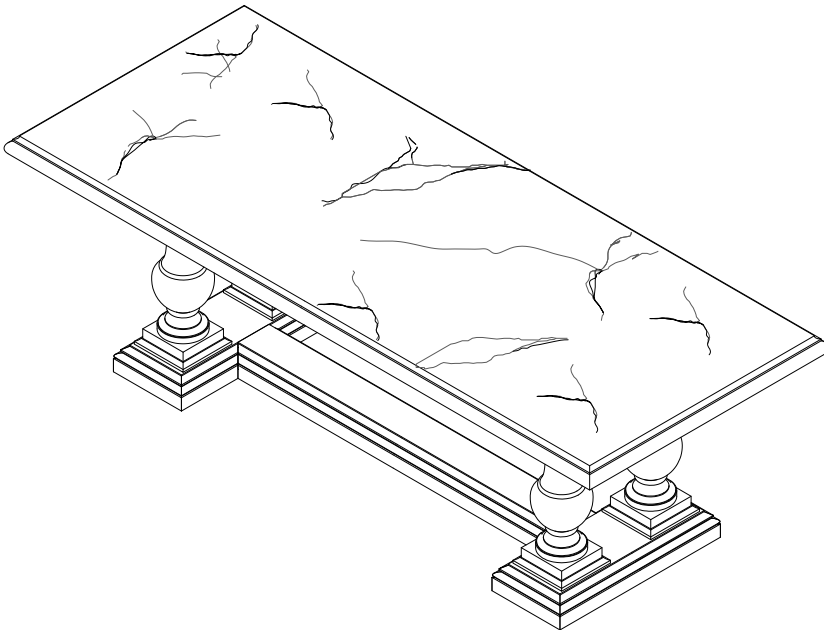

CARE INSTRUCTIONS









1. Dust often using a clean, soft, dry and lint-free cloth.
2. Blot spills immediately and wipe with a clean, damp cloth.
3. We do not recommend the use of chemical cleansers, abrasives or furniture polish on our lacquered finish.

IMPORTANT SAFETY INSTRUCTIONS





1. Please read all instructions carefully before assembling.
2. For your safety, assembly by two or more adults is strongly recommended.
3. Keep these instructions for future use.
4. Use only vendor supplied hardware to assemble. Using unauthorized hardware could jeopardize the structural integrity of the item.

HARDWARE INCLUDED

(Packed inside the Base)

NO.	ITEM	DESCRIPTION	QTY.
1		Threaded rod	4 pcs.
2		Curved washer	4 pcs.
3		Lock washer	8 pcs.
4		Hex nut	4 pcs.
5		Wrench	4 pcs.
6		Allen bolt	4 pcs.
7		Plain washer	4 pcs.
8		Allen wrench	1 pc.

(Packed inside the Marble top)

NO.	ITEM	DESCRIPTION	QTY.
9		Allen bolt	10 pcs.
10		Lock washer	10 pcs.
11		Plain washer	10 pcs.
12		Allen wrench	1 pc.

RH

ST. JAMES 96" & 108" MARBLE DINING TABLE INSTRUCTIONS

ASSEMBLY INSTRUCTIONS:

1. Gently turn both bases (B) upside down with inside surfaces facing each other and leave enough space to assemble the stretcher (C&D) in-between as shown in Figure 2.
2. Secure the threaded rod (1) to the fixed nut on the base (B) by simply turning it manually.
3. Raise the top stretcher (C) and set it in the cavity; place the rod (1) to align with the holes on the end of the stretcher (C). Position the stretcher (C) against the base (B) so the threaded rods (1) go through the holes. Insert curved washer (2) and lock washer (3) and place hex nuts (4) on threaded rod (1), then tighten the hex nuts (4) with wrench (5), as shown in FIGURE 1.
4. On inside surface of the bases (B) there is a cavity for the stretcher (D) with holes for the wooden dowel to pass through that correspond to the holes on both ends of the stretcher (D). Install the stretcher (C) into the cavity of the base (B) and once the stretcher is set engage Allen bolt (6) together with Lock washer (3) and Plain washer (7). Please see FIGURE 2.
5. **KEEP HOLDING THE BOTTOM STRETCHER (D)** while repeating steps #2 - #4 for the other base (B).
6. After assembly, gently turn the base upright and place in your desired location.
7. On mounting plate of base are pre-installed locator blocks that fit on the frame underneath the tabletop. Gently lift up the marble top (A) and install on top of the base; engage Allen head bolt (9) with lock washer (10) and plain washer (11) underneath the mounting plate of the base. Please see FIGURE 3.
8. Assembly is complete.

