

CHELSEA MOTION COLLECTION

All dimensions are given in inches. See the attached "Dimensions Diagram" sheet for more information on the keys used in this chart.



	OVERALL DIMENSIONS				MOTION					SEAT			ARM			FOOT	CUSHIONS		
	OVERALL WIDTH [A]	OVERALL DEPTH [B]	OVERALL HEIGHT [C]	FRAME HEIGHT [D]	FULLY RECLINED DEPTH [E]	RECLINING CLEARANCE NEEDED (BACK OF ARM) [F]	RECLINING CLEARANCE NEEDED (FRONT OF ARM) [G]	FULLY RECLINED BACK HEIGHT [H]	FULLY RAISED FOOTREST HEIGHT [I]	INSIDE SEAT WIDTH [J]	SEAT HEIGHT [K]	INSIDE BACK HEIGHT TO TOP OF SEAT [L]	ARM WIDTH [M]	ARM HEIGHT [N]	TOP OF ARM TO TOP OF SEAT [O]	FOOT HEIGHT [P]	NUMBER OF BACK CUSHIONS	NUMBER OF SEAT CUSHIONS	NUMBER OF ACCENT PILLOWS
CHAIR	43½	44	34¾	34¾	-	-	-	-	-	27	17¾	17	8¾	23½	5¾	2	-	-	-
RECLINER	43½	44	34¾	34¾	65½	7	18	27¾	19	27	17¾	17	8¾	23½	5¾	2	-	-	-
SWIVEL CHAIR	43½	44	34¾	34¾	-	-	-	-	-	27	17¾	17	8¾	23½	5¾	-	-	-	-
ARMLESS CHAIR	32	44	34¾	34¾	-	-	-	-	-	32	17¾	17	-	-	5¾	2	-	-	-
ARMLESS RECLINER	32	44	34¾	34¾	65½	7	18	27¾	20½	32	17¾	17	-	-	5¾	2	-	-	-
ARMLESS SWIVEL CHAIR	32	44	34¾	34¾	-	-	-	-	-	32	17¾	17	-	-	5¾	-	-	-	-
MODULAR LEFT-ARM MOTION CHAIR	47¾	48	34¾	34¾	67¾	7	18	26½	21¼	36¾	17¾	17	11	23½	5¾	2	-	-	-
MODULAR LEFT-ARM STATIONARY CHAIR	47¾	48	34¾	34¾	-	-	-	-	-	36¾	17¾	17	11	23½	5¾	2	-	-	-
MODULAR RIGHT-ARM MOTION CHAIR	47¾	48	34¾	34¾	67¾	7	18	26½	21¼	36¾	17¾	17	11	23½	5¾	2	-	-	-
MODULAR RIGHT-ARM STATIONARY CHAIR	47¾	48	34¾	34¾	-	-	-	-	-	36¾	17¾	17	11	23½	5¾	2	-	-	-
MODULAR ARMLESS MOTION CHAIR	36¾	48	34¾	34¾	67¾	7	18	26½	21¼	36¾	17¾	17	-	-	5¾	2	-	-	-
MODULAR ARMLESS STATIONARY CHAIR	36¾	48	34¾	34¾	-	-	-	-	-	36¾	17¾	17	-	-	5¾	2	-	-	-
58" MODULAR STATIONARY CORNER CHAIR	58	58	34¾	34¾	-	-	-	-	-	57	17¾	17	-	-	5¾	2	-	-	-
64½" MODULAR STATIONARY CORNER CHAIR	64½	64½	34¾	34¾	-	-	-	-	-	66¾	17¾	17	-	-	5¾	2	-	-	-

CHELSEA MOTION DIMENSIONS DIAGRAM

See the "Dimensions Sheet" for the measurements that correspond with the letters below.

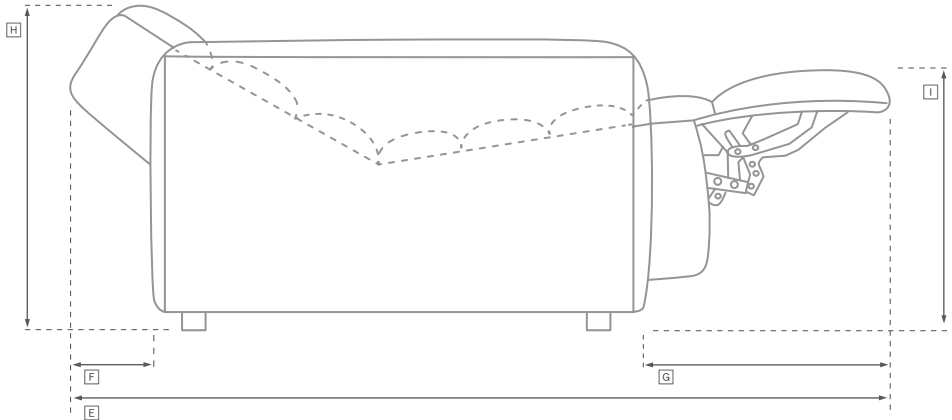
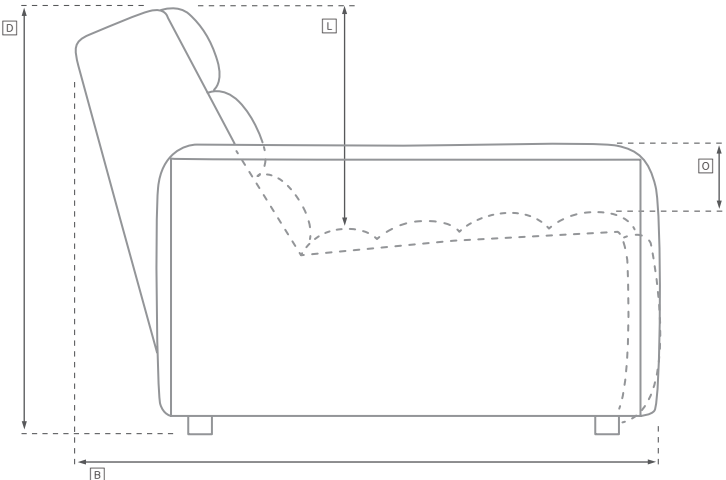
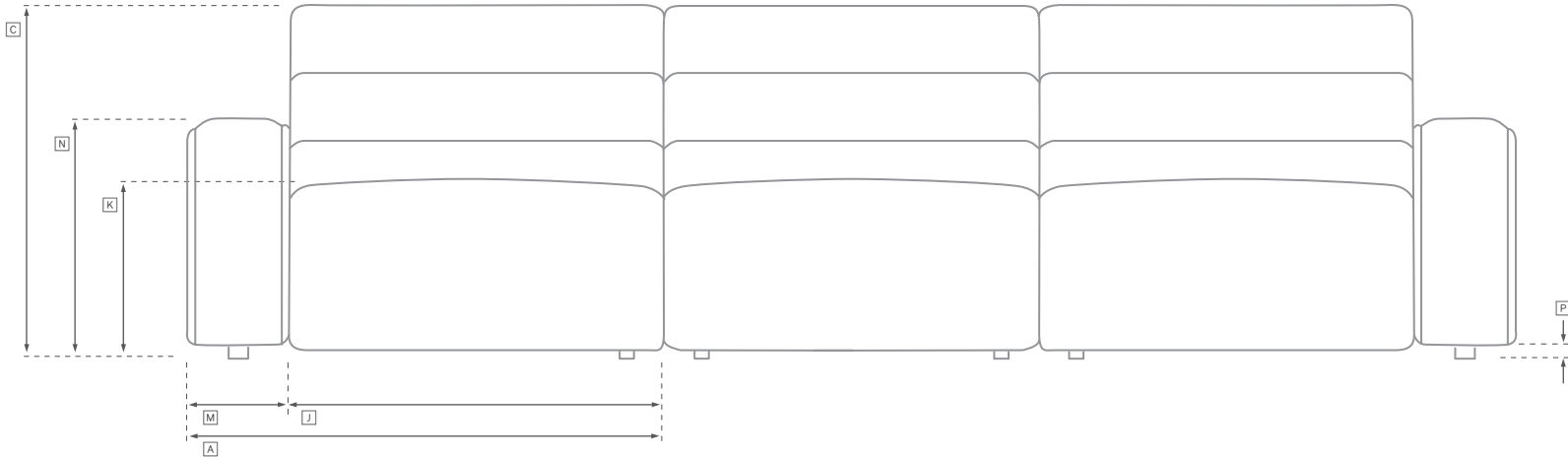

CHELSEA MOTION MODULAR L-SECTIONAL CORNER CHAIR CONFIGURATION

See the "Dimensions Sheet" for the measurements that correspond with the letters below.

RH

58" CORNER CHAIR

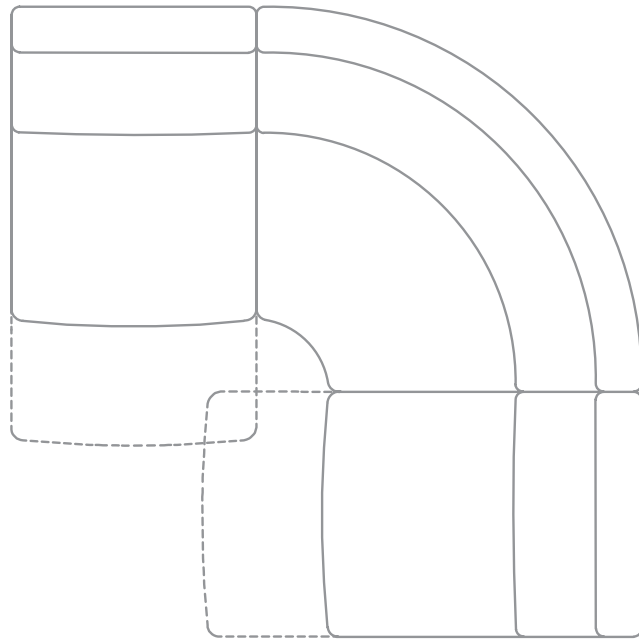

The 58" Corner Chair allows space for one footrest on adjacent reclining chair to be fully raised.

Footrests on both adjacent reclining chairs can be raised at the same time at lower angles.

64½" CORNER CHAIR

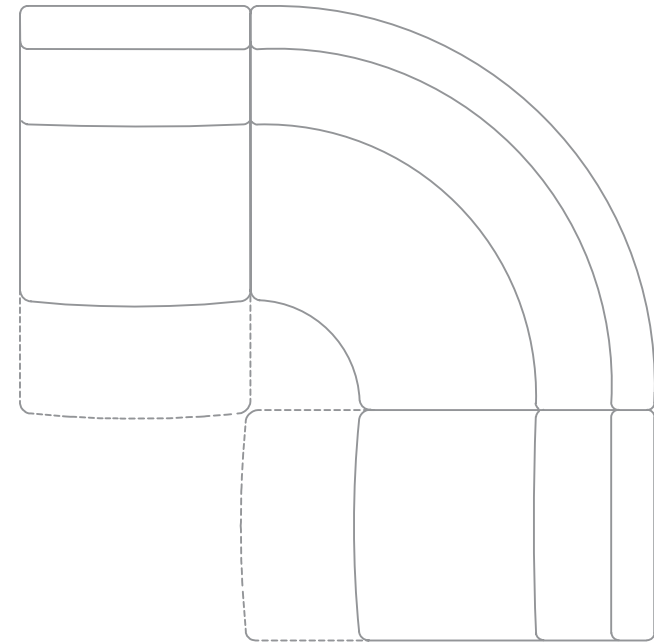

The 64½" Corner Chair allows space for reclining chair on either side to extend fully with both footrests raised.

CHELSEA MOTION MODULAR ARMLESS RECLINER CHAIR BUTTON PLACEMENT

See the "Dimensions Sheet" for the measurements that correspond with the letters below.

RH

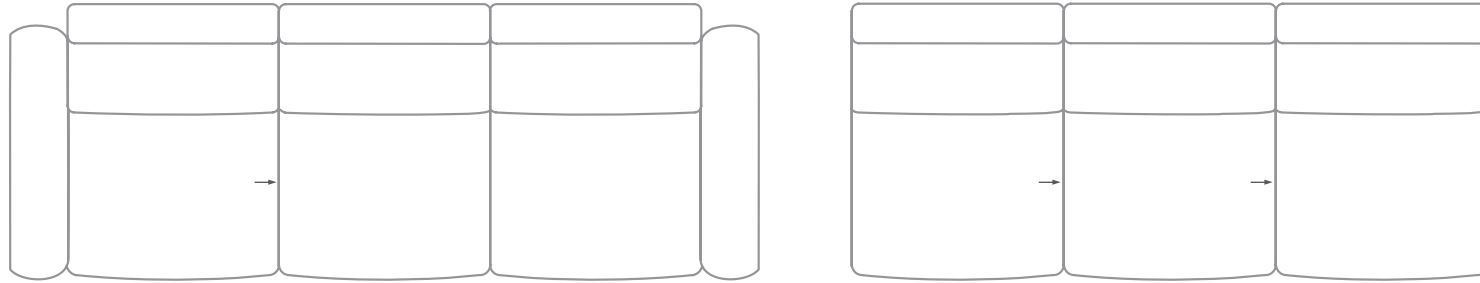

The motion controller buttons on an armless reclining chair will not be visible when placed next to another sectional component.

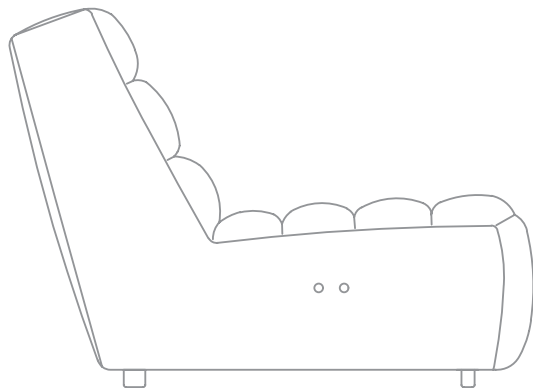

To operate the motion controller, reach down the right-hand side of the armless reclining chair.

Buttons are located in the middle of the seat, 6" below the side seam.

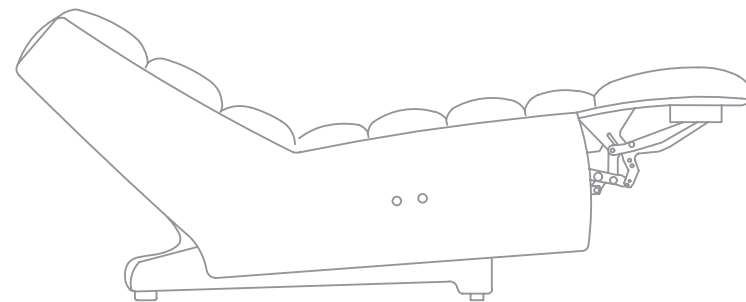

Front button reclines the back rest and raises the footrest.
Back button returns to closed position.

MODULAR 2-PIECE SOFA

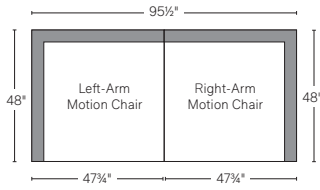

MODULAR 3-PIECE SOFA

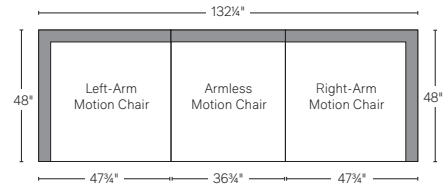

MODULAR 4-PIECE SOFA

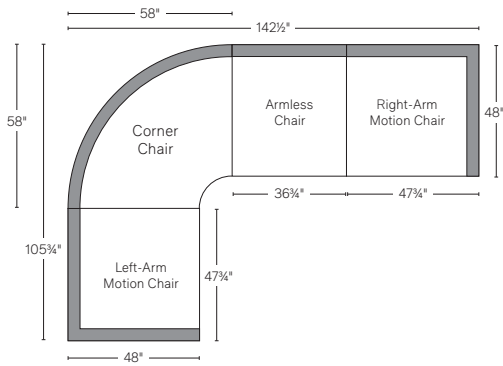

MODULAR 5-PIECE SOFA

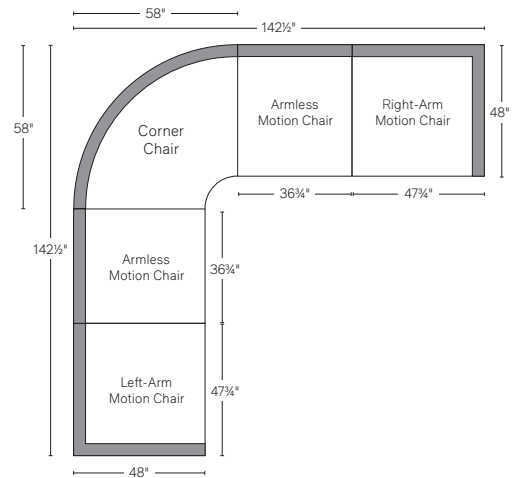

MODULAR 6-PIECE SOFA

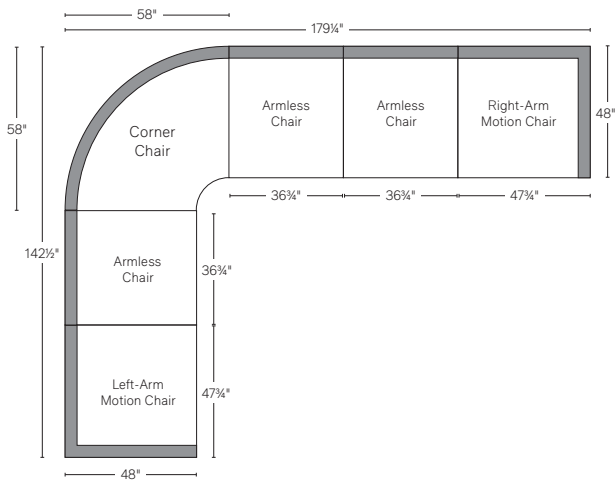

MODULAR 2-PIECE SOFA

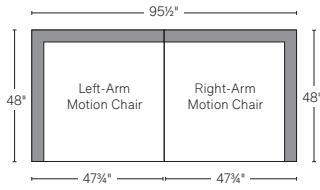

MODULAR 3-PIECE SOFA

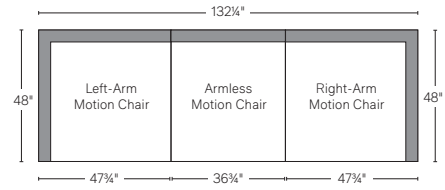

MODULAR 4-PIECE SOFA

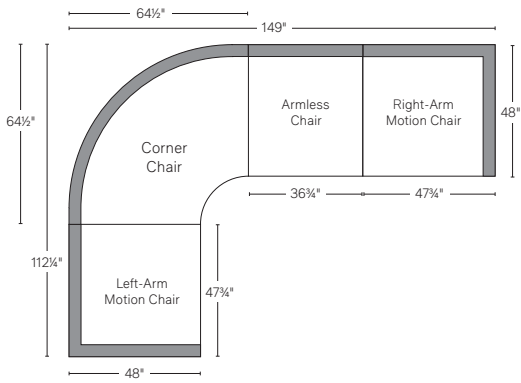

MODULAR 5-PIECE SOFA

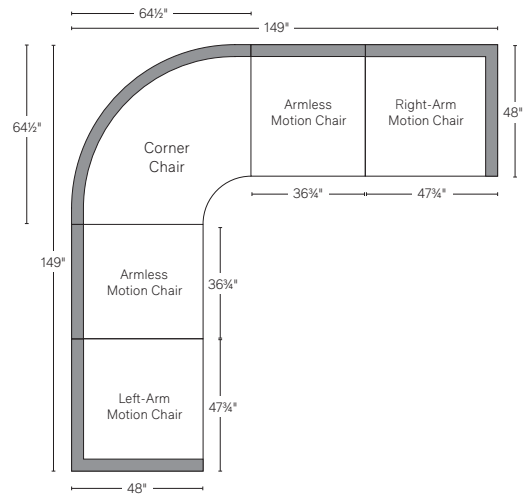

MODULAR 6-PIECE SOFA

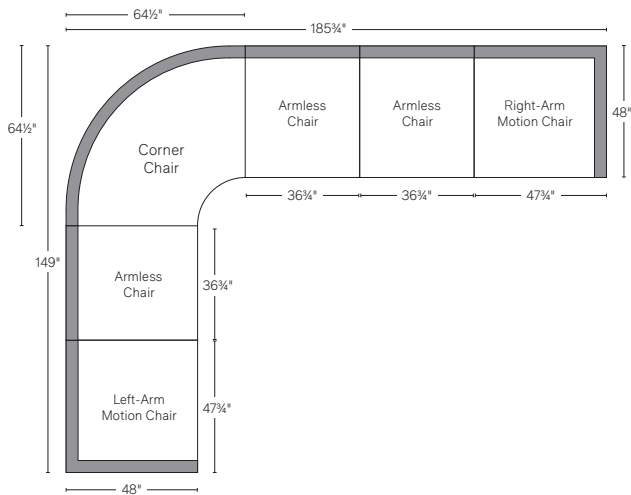

MODULAR 2-PIECE SOFA

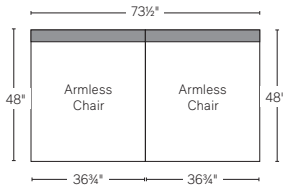

MODULAR 3-PIECE SOFA

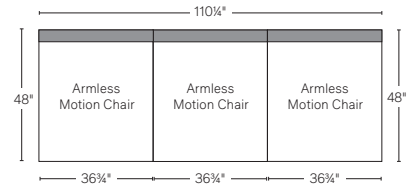

MODULAR 4-PIECE SOFA

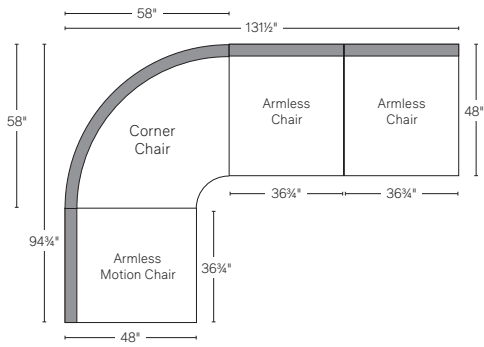

MODULAR 5-PIECE SOFA

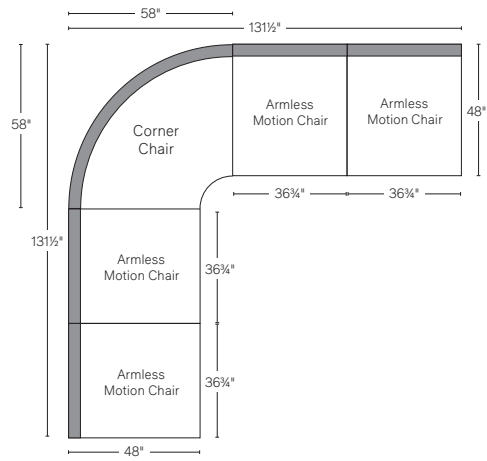

MODULAR 6-PIECE SOFA

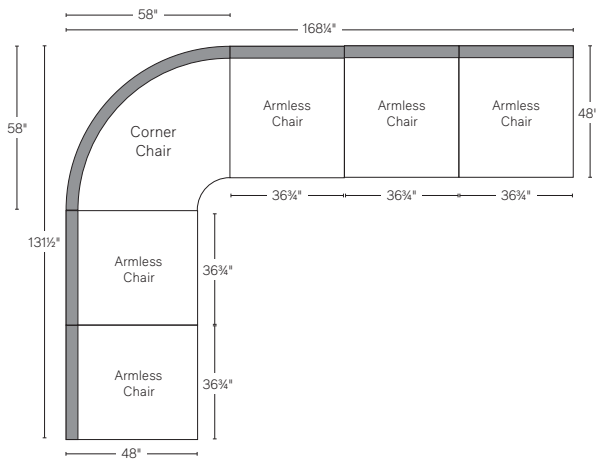

MODULAR 2-PIECE SOFA

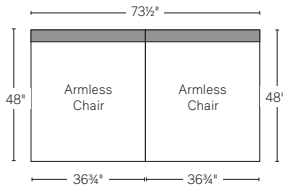

MODULAR 3-PIECE SOFA

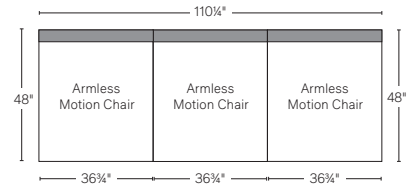

MODULAR 4-PIECE SOFA

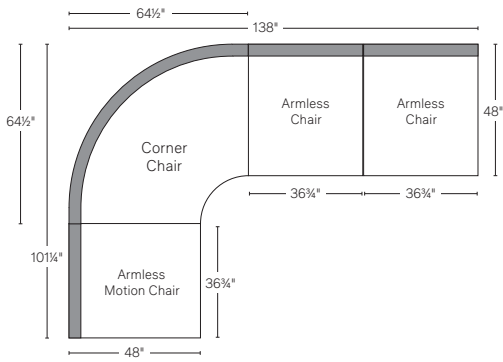

MODULAR 5-PIECE SOFA

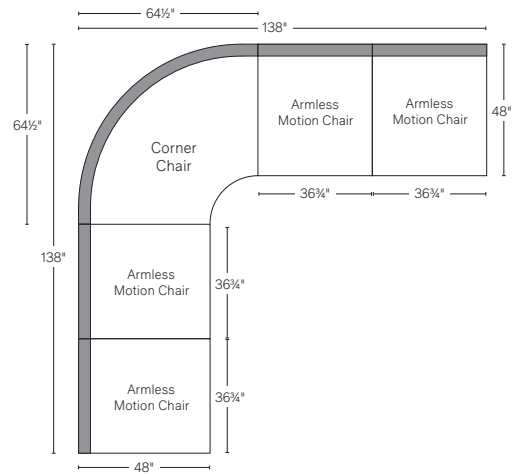

MODULAR 6-PIECE SOFA

