

# RH

METAL DOVETAIL MIRROR - WIDE FRAME

26" x 48" (66cm x 122cm)

ASSEMBLY AND INSTALLATION INSTRUCTIONS

**ENGLISH**

**METAL DOVETAIL MIRROR - WIDE FRAME**

**PART LIST**

- (A) Mirror With Bracket x 1 pc.
- (B) Screw - M4 x 30mm x 5 pcs.
- (C) EZ Mini Anchor 14 x 44mm x 5 pcs.
- (D) Aluminum Hanger 18" (46 cm) x 1 pc.

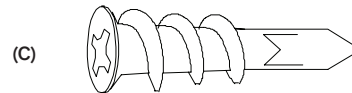
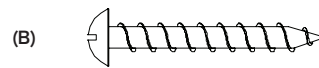
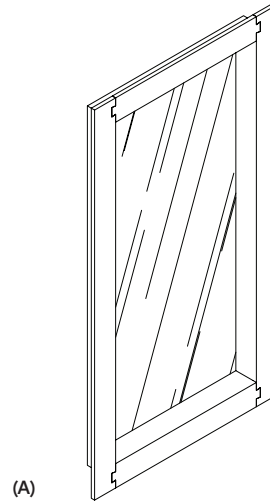

**STORAGE**

1. Do not stack anything on top of the mirror
2. Keep the mirror packaged until installation.
3. Store mirror upright on the long edge.

**MIRROR HANDLING INSTRUCTIONS****CAUTION**

1. Remove vertically from package.
2. Always carry mirror vertically as illustrated.  
Carrying flat will cause breakage.

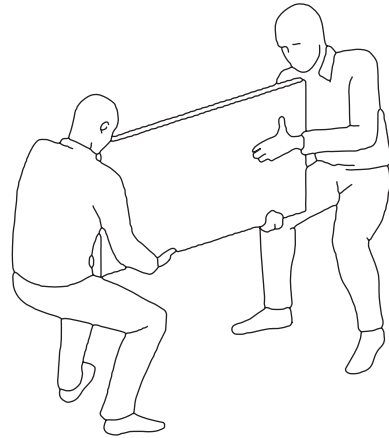
**BEFORE YOU BEGIN**

1. Professional installation recommended.
2. Tool and materials required:  
Carpenter's level  
Phillips head screwdriver
3. These instructions are provided for your safety. It is important that they are read carefully and completely before installation of the fixture.
4. For your safety, it is recommended that two people hang the fixture.
5. Check with a professional to ensure your wall can tolerate a fixture weighing 41 lbs (19 kg).
6. When wall mounting, stud mounting is strongly recommended.

**INSTALLATION OF MIRROR**

1. Unpack all parts and place them on a protected work surface.
2. Determine the exact location of the fixture and mark the holes on the wall surface using the holes in the aluminum hanger (D) as a guide.
3. Drill small holes on each point location on the wall. Each hole should be just large enough to accommodate EZ mini anchor (C).
4. Insert the EZ mini anchors (C) into the holes on the wall.
5. Mount the aluminum hanger (D) into the wall using screws (B).
6. Check that the aluminum hanger fixture is securely screwed into the wall.
7. Place the mirror with hanger cleat (A) into the aluminum hanger fixture.
8. Installation is complete.

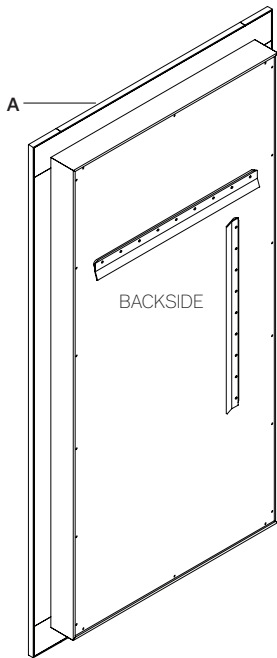

FIGURE 1

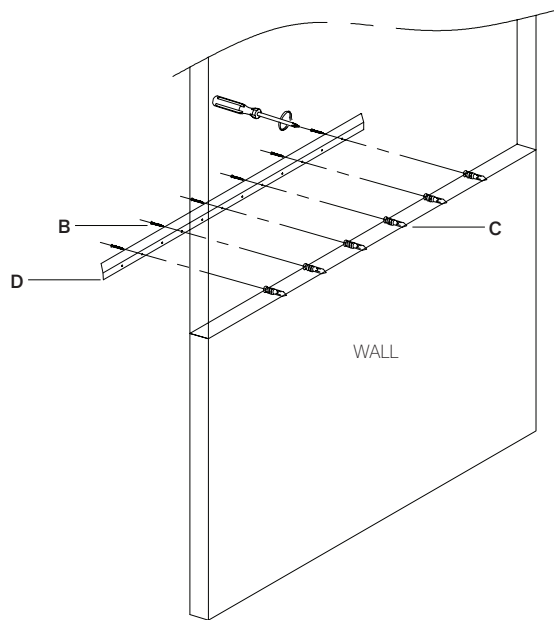

FIGURE 1

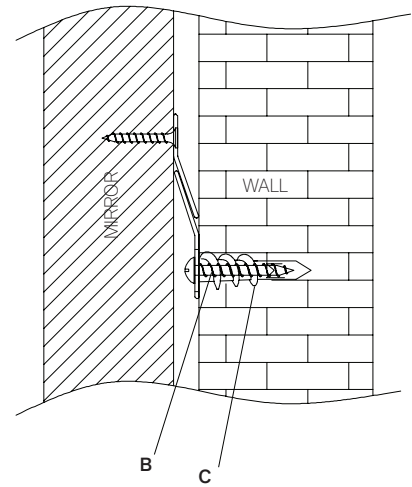

FIGURE 1

**\*\*NOTE: MAKE SURE THAT THE TWO (2) CLEATS (1 ON MIRROR AND 1 ON WALL) ARE LOCKED AND SECURED WITH EACH OTHER. A LEVEL CHECK IS HIGHLY RECOMMENDED. CHECK AND ADJUST IF NEEDED.**

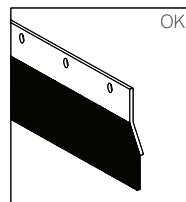

FIGURE 3

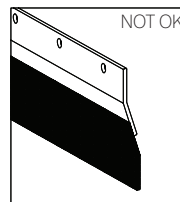

FIGURE 4

**CLEANING INSTRUCTIONS**

To clean, use a soft dry or damp cloth.  
Do not use abrasive cleaners.

# RH

METAL DOVETAIL MIRROR - WIDE FRAME

36" x 48" (91cm x 122cm)

ASSEMBLY AND INSTALLATION INSTRUCTIONS

**ENGLISH**

**METAL DOVETAIL MIRROR - WIDE FRAME**

**PART LIST**

- (A) Mirror With Bracket x 1 pc.
- (B) Screw - M4 x 30mm x 6 pcs.
- (C) EZ Mini Anchor 14 x 44mm x 6 pcs.
- (D) Aluminum Hanger 24" (61 cm) x 1 pc.

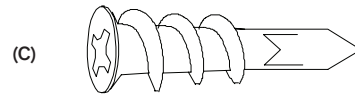
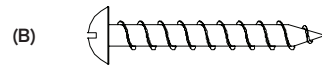
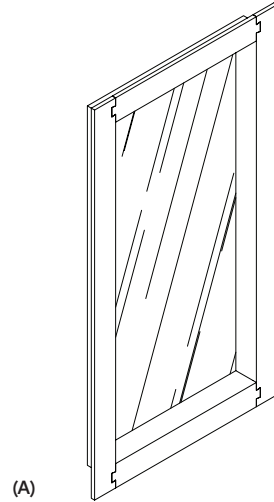

**STORAGE**

1. Do not stack anything on top of the mirror
2. Keep the mirror packaged until installation.
3. Store mirror upright on the long edge.

**MIRROR HANDLING INSTRUCTIONS****CAUTION**

1. Remove vertically from package.
2. Always carry mirror vertically as illustrated.  
Carrying flat will cause breakage.

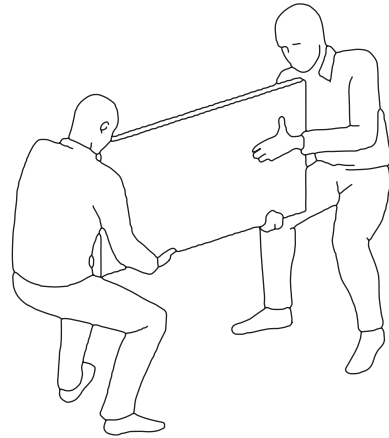
**BEFORE YOU BEGIN**

1. Professional installation recommended.
2. Tool and materials required:  
Carpenter's level  
Phillips head screwdriver
3. These instructions are provided for your safety. It is important that they are read carefully and completely before installation of the fixture.
4. For your safety, it is recommended that two people hang the fixture.
5. Check with a professional to ensure your wall can tolerate a fixture weighing 55 lbs (25 kg).
6. When wall mounting, stud mounting is strongly recommended.

**INSTALLATION OF MIRROR**

1. Unpack all parts and place them on a protected work surface.
2. Determine the exact location of the fixture and mark the holes on the wall surface using the holes in the aluminum hanger (D) as a guide.
3. Drill small holes on each point location on the wall. Each hole should be just large enough to accommodate EZ mini anchor (C).
4. Insert the EZ mini anchors (C) into the holes on the wall.
5. Mount the aluminum hanger (D) into the wall using screws (B).
6. Check that the aluminum hanger fixture is securely screwed into the wall.
7. Place the mirror with hanger cleat (A) into the aluminum hanger fixture.
8. Installation is complete.

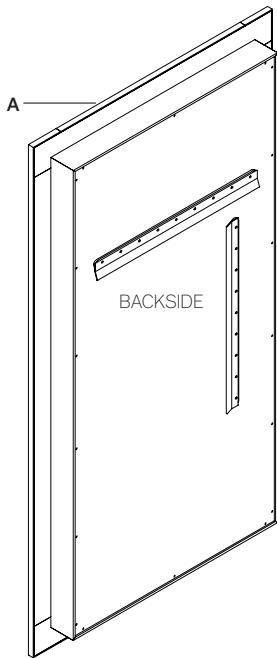

FIGURE 1

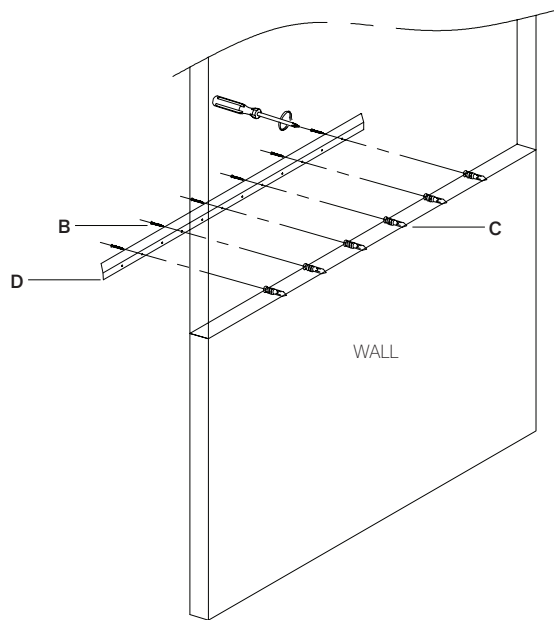

FIGURE 1

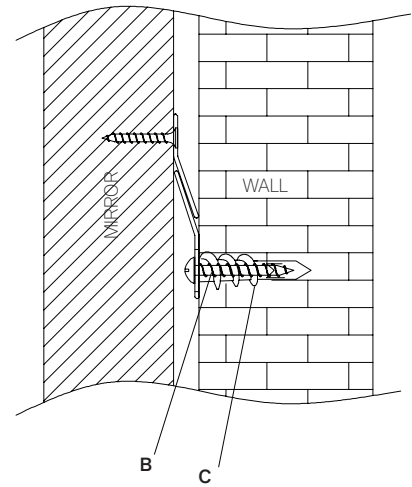

FIGURE 1

**\*\*NOTE: MAKE SURE THAT THE TWO (2) CLEATS (1 ON MIRROR AND 1 ON WALL) ARE LOCKED AND SECURED WITH EACH OTHER. A LEVEL CHECK IS HIGHLY RECOMMENDED. CHECK AND ADJUST IF NEEDED.**

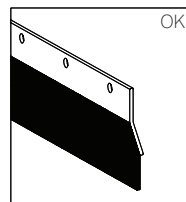

FIGURE 3

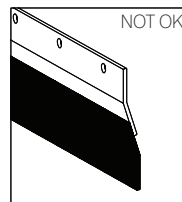

FIGURE 4

**CLEANING INSTRUCTIONS**

To clean, use a soft dry or damp cloth.  
Do not use abrasive cleaners.