

MODENA SLOPE ARM COLLECTION



All dimensions are given in inches. See the attached "Dimensions Diagram" sheet for more information on the keys used in this chart.

	A	B	C	D	E	F	G	H	I	J	K	L		M	N				O	P	Q	R	S
	OVERALL WIDTH	OVERALL DEPTH	OVERALL HEIGHT	FRAME HEIGHT	SEAT HEIGHT	ARM HEIGHT	FOOT HEIGHT	SEAT HEIGHT (FLOOR TO CUSHION SEAM)	SEAT HEIGHT (FLOOR TO FRAME)	INSIDE SEAT WIDTH	INSIDE SEAT DEPTH W/ BACK CUSHION	INSIDE SEAT DEPTH W/O BACK CUSHION	INSIDE BACK HEIGHT W/ SEAT & BACK CUSHIONS	INSIDE BACK HEIGHT W/ SEAT CUSHION	INSIDE BACK HEIGHT W/O SEAT OR BACK CUSHION	# OF BACK CUSHIONS	# OF SEAT CUSHIONS	ACCENT PILLOWS	ARM HEIGHT W/ SEAT CUSHION	ARM HEIGHT W/O SEAT CUSHION	ARM WIDTH	SLEEPER DEPTH OVERALL	SLEEPER DEPTH INSIDE
6' PETITE SOFA*	72	37	29	26	16	20	1¾	14½	9	63	22	29	13	10	17	2	2	0	4	11	4½	-	-
6' CLASSIC SOFA*	72	41	30	28½	16	21	1¾	14½	9	61	23½	31¾	14	12½	18½	2	2	0	5	11	5½	-	-
7' PETITE SOFA*	84	37	29	26	16	20	1¾	14½	9	75	22	29	13	10	17	2	2	0	4	11	4½	-	-
7' CLASSIC SOFA*	84	41	30	28½	16	21	1¾	14½	9	73	23½	31¾	14	12½	18½	2	2	0	5	11	5½	-	-
7' LUXE SOFA*	84	45	30	28½	16	21	1¾	14½	9	73	27½	35¾	14	12½	18½	2	2	0	5	11	5½	-	-
8' PETITE SOFA*	96	37	29	26	16	20	1¾	14½	9	87	22	29	13	10	17	2	2	0	4	11	4½	-	-
8' CLASSIC SOFA*	96	41	30	28½	16	21	1¾	14½	9	85	23½	31¾	14	12½	18½	2	2	0	5	11	5½	-	-
8' LUXE SOFA*	96	45	30	28½	16	21	1¾	14½	9	85	27½	35¾	14	12½	18½	2	2	0	5	11	5½	-	-
9' PETITE SOFA*	108	37	29	26	16	20	1¾	14½	9	99	22	29	13	10	17	2	2	0	4	11	4½	-	-
9' CLASSIC SOFA*	108	41	30	28½	16	21	1¾	14½	9	97	23½	31¾	14	12½	18½	2	2	0	5	11	5½	-	-
9' LUXE SOFA*	108	45	30	28½	16	21	1¾	14½	9	97	27½	35¾	14	12½	18½	2	2	0	5	11	5½	-	-
10' CLASSIC SOFA*	120	41	30	28½	16	21	1¾	14½	9	109	23½	31¾	14	12½	18½	2	2	0	5	11	5½	-	-
10' LUXE SOFA*	120	45	30	28½	16	21	1¾	14½	9	109	27½	35¾	14	12½	18½	2	2	0	5	11	5½	-	-
PETITE CHAIR	35	37	29	26	16	20	1¾	14½	9	26	22	29	13	10	17	1	1	0	4	11	4½	-	-

* ALSO AVAILABLE WITH 1 SEAT CUSHION

MODENA SLOPE ARM COLLECTION



All dimensions are given in inches. See the attached "Dimensions Diagram" sheet for more information on the keys used in this chart.

	A	B	C	D	E	F	G	H	I	J	K	L	INSIDE BACK HEIGHT W/ SEAT & BACK CUSHIONS	M	N	# OF BACK CUSHIONS	# OF SEAT CUSHIONS	ACCENT PILLOWS	O	P	Q	R	S
	OVERALL WIDTH	OVERALL DEPTH	OVERALL HEIGHT	FRAME HEIGHT	SEAT HEIGHT	ARM HEIGHT	FOOT HEIGHT	SEAT HEIGHT (FLOOR TO CUSHION SEAM)	SEAT HEIGHT (FLOOR TO FRAME)	INSIDE SEAT WIDTH	INSIDE SEAT DEPTH W/ BACK CUSHION	INSIDE SEAT DEPTH W/O BACK CUSHION	INSIDE BACK HEIGHT W/ SEAT & BACK CUSHIONS	INSIDE BACK HEIGHT W/ SEAT CUSHION	INSIDE BACK HEIGHT W/O SEAT OR BACK CUSHION	# OF BACK CUSHIONS	# OF SEAT CUSHIONS	ACCENT PILLOWS	ARM HEIGHT W/ SEAT CUSHION	ARM HEIGHT W/O SEAT CUSHION	ARM WIDTH	SLEEPER DEPTH OVERALL	SLEEPER DEPTH INSIDE
CLASSIC CHAIR	42	41	30	28½	16	21	1¼	14½	9	31	23½	31¾	14	12½	18½	1	1	0	5	11	5½	-	-
LUXE CHAIR	42	45	30	28½	16	21	1¼	14½	9	31	27½	35¾	14	12½	18½	1	1	0	5	11	5½	-	-
LUXE CHAISE	46	72	30	28½	16	21	1¼	14½	9	35	55¼	62¾	14	12½	18½	1	1	0	5	11	5½	-	-
SMALL BENCH	57	28	20½	20½	16	20½	1¼	14½	9	46	-	-	-	-	-	-	1	-	4½	11½	5½	-	-
LARGE BENCH	92	39½	20½	20½	16	20½	1¼	14½	9	77	-	-	-	-	-	-	1	-	4½	11½	7½	-	-
PETITE OTTOMAN	30	26	16	16	16	-	1¼	16	9	30	-	-	-	-	-	-	1	-	-	-	-	-	-
LUXE OTTOMAN	34	28	16	16	16	-	1¼	16	9	34	-	-	-	-	-	-	1	-	-	-	-	-	-
COFFEE OTTOMAN	57	28	16	16	16	-	1¼	16	9	57	-	-	-	-	-	-	1	-	-	-	-	-	-
5' CLASSIC ARMLESS SOFA*	60	41	30	28½	16	-	1¼	14½	9	60	23½	31¾	14	12½	18½	2	2	0	-	-	-	-	-
6' CLASSIC ARMLESS SOFA*	72	41	30	28½	16	-	1¼	14½	9	72	23½	31¾	14	12½	18½	2	2	0	-	-	-	-	-
6' LUXE ARMLESS SOFA*	72	45	30	28½	16	-	1¼	14½	9	72	27½	35¾	14	12½	18½	2	2	0	-	-	-	-	-
7' CLASSIC ARMLESS SOFA*	84	41	30	28½	16	-	1¼	14½	9	84	23½	31¾	14	12½	18½	2	2	0	-	-	-	-	-
7' LUXE ARMLESS SOFA*	84	45	30	28½	16	-	1¼	14½	9	84	27½	35¾	14	12½	18½	2	2	0	-	-	-	-	-
8' CLASSIC ARMLESS SOFA*	96	41	30	28½	16	-	1¼	14½	9	96	23½	31¾	14	12½	18½	2	2	0	-	-	-	-	-

* ALSO AVAILABLE WITH 1 SEAT CUSHION

MODENA SLOPE ARM COLLECTION



All dimensions are given in inches. See the attached "Dimensions Diagram" sheet for more information on the keys used in this chart.

	A	B	C	D	E	F	G	H	I	J	K	L		M	N				O	P	Q	R	S
	OVERALL WIDTH	OVERALL DEPTH	OVERALL HEIGHT	FRAME HEIGHT	SEAT HEIGHT	ARM HEIGHT	FOOT HEIGHT	SEAT HEIGHT (FLOOR TO CUSHION SEAM)	SEAT HEIGHT (FLOOR TO FRAME)	INSIDE SEAT WIDTH	INSIDE SEAT DEPTH W/ BACK CUSHION	INSIDE SEAT DEPTH W/O BACK CUSHION	INSIDE BACK HEIGHT W/ SEAT & BACK CUSHIONS	INSIDE BACK HEIGHT W/ SEAT CUSHION	INSIDE BACK HEIGHT W/O SEAT OR BACK CUSHION	# OF BACK CUSHIONS	# OF SEAT CUSHIONS	ACCENT PILLOWS	ARM HEIGHT W/ SEAT CUSHION	ARM HEIGHT W/O SEAT CUSHION	ARM WIDTH	SLEEPER DEPTH OVERALL	SLEEPER DEPTH INSIDE
8' LUXE ARMLESS SOFA*	96	45	30	28½	16	-	1¼	14½	9	96	27½	35¾	14	12½	18½	2	2	0	-	-	-	-	-
6' CLASSIC LEFT-ARM SOFA*	72	41	30	28½	16	21	1¼	14½	9	66½	23½	31¾	14	12½	18½	2	2	0	5	11	5½	-	-
6' CLASSIC RIGHT-ARM SOFA*	72	41	30	28½	16	21	1¼	14½	9	66½	23½	31¾	14	12½	18½	2	2	0	5	11	5½	-	-
6' LUXE LEFT-ARM SOFA*	72	45	30	28½	16	21	1¼	14½	9	66½	27½	35¾	14	12½	18½	2	2	0	5	11	5½	-	-
6' LUXE RIGHT-ARM SOFA*	72	45	30	28½	16	21	1¼	14½	9	66½	27½	35¾	14	12½	18½	2	2	0	5	11	5½	-	-
7' CLASSIC LEFT-ARM SOFA*	84	41	30	28½	16	21	1¼	14½	9	78½	23½	31¾	14	12½	18½	2	2	0	5	11	5½	-	-
7' CLASSIC RIGHT-ARM SOFA*	84	41	30	28½	16	21	1¼	14½	9	78½	23½	31¾	14	12½	18½	2	2	0	5	11	5½	-	-
7' LUXE LEFT-ARM SOFA*	84	45	30	28½	16	21	1¼	14½	9	78½	27½	35¾	14	12½	18½	2	2	0	5	11	5½	-	-
7' LUXE RIGHT-ARM SOFA*	84	45	30	28½	16	21	1¼	14½	9	78½	27½	35¾	14	12½	18½	2	2	0	5	11	5½	-	-
8' CLASSIC LEFT-ARM SOFA*	96	41	30	28½	16	21	1¼	14½	9	90½	23½	31¾	14	12½	18½	2	2	0	5	11	5½	-	-
8' CLASSIC RIGHT-ARM SOFA*	96	41	30	28½	16	21	1¼	14½	9	90½	23½	31¾	14	12½	18½	2	2	0	5	11	5½	-	-
8' LUXE LEFT-ARM SOFA*	96	45	30	28½	16	21	1¼	14½	9	90½	27½	35¾	14	12½	18½	2	2	0	5	11	5½	-	-
8' LUXE RIGHT-ARM SOFA*	96	45	30	28½	16	21	1¼	14½	9	90½	27½	35¾	14	12½	18½	2	2	0	5	11	5½	-	-
9' CLASSIC LEFT-ARM SOFA**	108	41	30	28½	16	21	1¼	14½	9	102½	23½	31¾	14	12½	18½	3	3	0	5	11	5½	-	-

* ALSO AVAILABLE WITH 1 SEAT CUSHION

** ALSO AVAILABLE WITH 2 BACK CUSHIONS AND 1 SEAT CUSHION

MODENA SLOPE ARM COLLECTION



All dimensions are given in inches. See the attached "Dimensions Diagram" sheet for more information on the keys used in this chart.

	A	B	C	D	E	F	G	H	I	J	K	L		M	N				O	P	Q	R	S
	OVERALL WIDTH	OVERALL DEPTH	OVERALL HEIGHT	FRAME HEIGHT	SEAT HEIGHT	ARM HEIGHT	FOOT HEIGHT	SEAT HEIGHT (FLOOR TO CUSHION SEAM)	SEAT HEIGHT (FLOOR TO FRAME)	INSIDE SEAT WIDTH	INSIDE SEAT DEPTH W/ BACK CUSHION	INSIDE SEAT DEPTH W/O BACK CUSHION	INSIDE BACK HEIGHT W/ SEAT & BACK CUSHIONS	INSIDE BACK HEIGHT W/ SEAT CUSHION	INSIDE BACK HEIGHT W/O SEAT OR BACK CUSHION	# OF BACK CUSHIONS	# OF SEAT CUSHIONS	ACCENT PILLOWS	ARM HEIGHT W/ SEAT CUSHION	ARM HEIGHT W/O SEAT CUSHION	ARM WIDTH	SLEEPER DEPTH OVERALL	SLEEPER DEPTH INSIDE
9' CLASSIC RIGHT-ARM SOFA**	108	41	30	28½	16	21	1¼	14½	9	102½	23½	31¾	14	12½	18½	3	3	0	5	11	5½	-	-
9' LUXE LEFT-ARM SOFA**	108	45	30	28½	16	21	1¼	14½	9	102½	27½	35¾	14	12½	18½	3	3	0	5	11	5½	-	-
9' LUXE RIGHT-ARM SOFA**	108	45	30	28½	16	21	1¼	14½	9	102½	27½	35¾	14	12½	18½	3	3	0	5	11	5½	-	-
7' CLASSIC LEFT-ARM RETURN SOFA*	84	41	30	28½	16	21	1¼	14½	9	61½	23½	31¾	14	12½	18½	3	2	0	5	11	5½	-	-
7' CLASSIC RIGHT-ARM RETURN SOFA*	84	41	30	28½	16	21	1¼	14½	9	61½	23½	31¾	14	12½	18½	3	2	0	5	11	5½	-	-
7' LUXE LEFT-ARM RETURN SOFA*	84	45	30	28½	16	21	1¼	14½	9	61½	27½	35¾	14	12½	18½	3	2	0	5	11	5½	-	-
7' LUXE RIGHT-ARM RETURN SOFA*	84	45	30	28½	16	21	1¼	14½	9	61½	27½	35¾	14	12½	18½	3	2	0	5	11	5½	-	-
8' CLASSIC LEFT-ARM RETURN SOFA*	96	41	30	28½	16	21	1¼	14½	9	73½	23½	31¾	14	12½	18½	3	2	0	5	11	5½	-	-
8' CLASSIC RIGHT-ARM RETURN SOFA*	96	41	30	28½	16	21	1¼	14½	9	73½	23½	31¾	14	12½	18½	3	2	0	5	11	5½	-	-
8' LUXE LEFT-ARM RETURN SOFA*	96	45	30	28½	16	21	1¼	14½	9	73½	27½	35¾	14	12½	18½	3	2	0	5	11	5½	-	-
8' LUXE RIGHT-ARM RETURN SOFA*	96	45	30	28½	16	21	1¼	14½	9	73½	27½	35¾	14	12½	18½	3	2	0	5	11	5½	-	-
9' CLASSIC LEFT-ARM RETURN SOFA†	108	41	30	28½	16	21	1¼	14½	9	85½	23½	31¾	14	12½	18½	4	3	0	5	11	5½	-	-
9' CLASSIC RIGHT-ARM RETURN SOFA†	108	41	30	28½	16	21	1¼	14½	9	85½	23½	31¾	14	12½	18½	4	3	0	5	11	5½	-	-
9' LUXE LEFT-ARM RETURN SOFA†	108	45	30	28½	16	21	1¼	14½	9	85½	27½	35¾	14	12½	18½	4	3	0	5	11	5½	-	-

* ALSO AVAILABLE WITH 1 SEAT CUSHION

** ALSO AVAILABLE WITH 2 BACK CUSHIONS AND 1 SEAT CUSHION

† ALSO AVAILABLE WITH 3 BACK CUSHIONS AND 1 SEAT CUSHION

MODENA SLOPE ARM COLLECTION



All dimensions are given in inches. See the attached "Dimensions Diagram" sheet for more information on the keys used in this chart.

	OVERALL WIDTH A	OVERALL DEPTH B	OVERALL HEIGHT C	FRAME HEIGHT D	SEAT HEIGHT E	ARM HEIGHT F	FOOT HEIGHT G	SEAT HEIGHT (FLOOR TO CUSHION SEAM) H	SEAT HEIGHT (FLOOR TO FRAME) I	INSIDE SEAT WIDTH J	INSIDE SEAT DEPTH W/ BACK CUSHION K	INSIDE SEAT DEPTH W/O BACK CUSHION L	INSIDE BACK HEIGHT W/ SEAT & BACK CUSHIONS M	INSIDE BACK HEIGHT W/ SEAT CUSHION N	# OF BACK CUSHIONS	# OF SEAT CUSHIONS	ACCENT PILLOWS	ARM HEIGHT W/ SEAT CUSHION O	ARM HEIGHT W/O SEAT CUSHION P	ARM WIDTH Q	SLEEPER DEPTH OVERALL R	SLEEPER DEPTH INSIDE S	
9' LUXE RIGHT-ARM RETURN SOFA†	108	45	30	28½	16	21	1¾	14½	9	85½	27½	35¾	14	12½	18½	4	3	0	5	11	5½	-	-
10' CLASSIC LEFT-ARM RETURN SOFA†	120	41	30	28½	16	21	1¾	14½	9	97½	23½	31¾	14	12½	18½	4	3	0	5	11	5½	-	-
10' CLASSIC RIGHT-ARM RETURN SOFA†	120	41	30	28½	16	21	1¾	14½	9	97½	23½	31¾	14	12½	18½	4	3	0	5	11	5½	-	-
10' LUXE LEFT-ARM RETURN SOFA†	120	45	30	28½	16	21	1¾	14½	9	97½	27½	35¾	14	12½	18½	4	3	0	5	11	5½	-	-
10' LUXE RIGHT-ARM RETURN SOFA†	120	45	30	28½	16	21	1¾	14½	9	97½	27½	35¾	14	12½	18½	4	3	0	5	11	5½	-	-
CLASSIC LEFT-ARM CHAISE	42	68	30	28½	16	21	1¾	14½	9	36½	50½	58¾	14	12½	18½	1	1	0	5	11	5½	-	-
CLASSIC RIGHT-ARM CHAISE	42	68	30	28½	16	21	1¾	14½	9	36½	50½	58¾	14	12½	18½	1	1	0	5	11	5½	-	-
LUXE LEFT-ARM CHAISE	44	72	30	28½	16	21	1¾	14½	9	38½	55¾	62¾	14	12½	18½	1	1	0	5	11	5½	-	-
LUXE RIGHT-ARM CHAISE	44	72	30	28½	16	21	1¾	14½	9	38½	55¾	62¾	14	12½	18½	1	1	0	5	11	5½	-	-
PETITE END-OF-SECTIONAL OTTOMAN	37	37	16	16	16	-	1¾	16	9	37	-	-	-	-	-	-	1	-	-	-	-	-	-
CLASSIC END-OF-SECTIONAL OTTOMAN	41	41	16	16	16	-	1¾	16	9	41	-	-	-	-	-	-	1	-	-	-	-	-	-
LUXE END-OF-SECTIONAL OTTOMAN	45	45	16	16	16	-	1¾	16	9	45	-	-	-	-	-	-	1	-	-	-	-	-	-
STORAGE OTTOMAN	57	28	16	16	16	-	1¾	15½	8	57	-	-	-	-	-	-	1	-	-	-	-	-	-

† ALSO AVAILABLE WITH 3 BACK CUSHIONS AND 1 SEAT CUSHION

UPHOLSTERY DIMENSIONS DIAGRAM

See the "Dimensions Sheet" for the measurements that correspond with the letters below.

RH

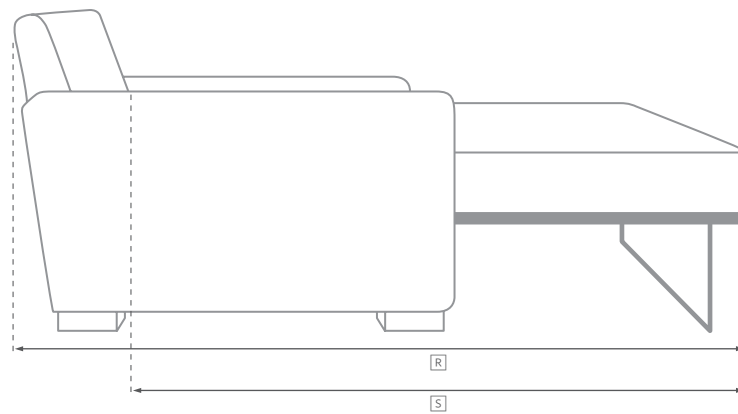
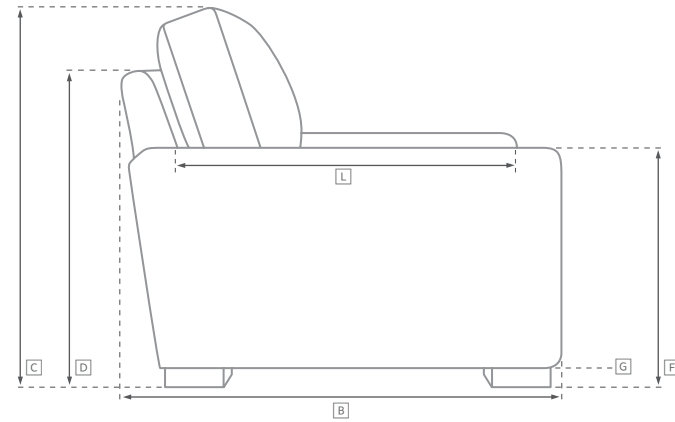
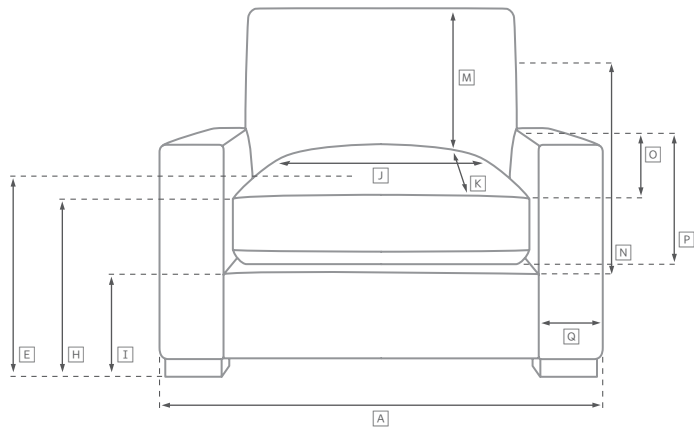

SOFA CHAISE SECTIONAL

Available in left and right-arm configurations.

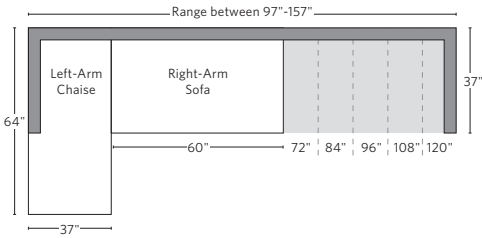

U-CHAISE SECTIONAL

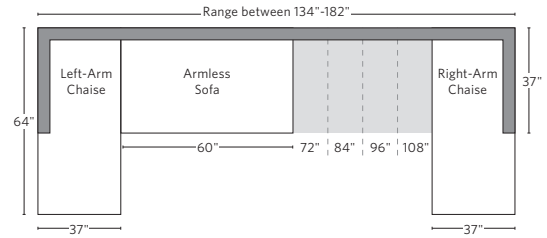

L-SECTIONAL

Available in left and right-arm configurations.

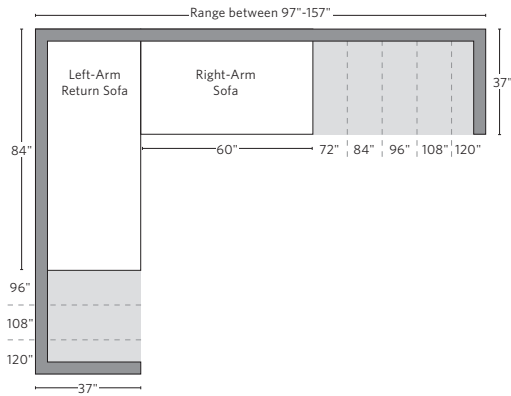

U-SOFA CHAISE SECTIONAL

Available in left and right-arm configurations.

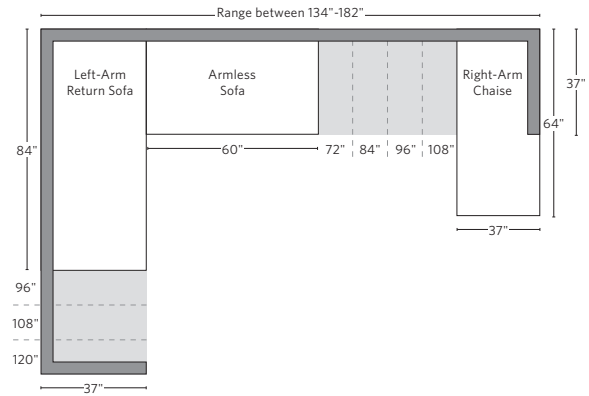

U-SOFA SECTIONAL

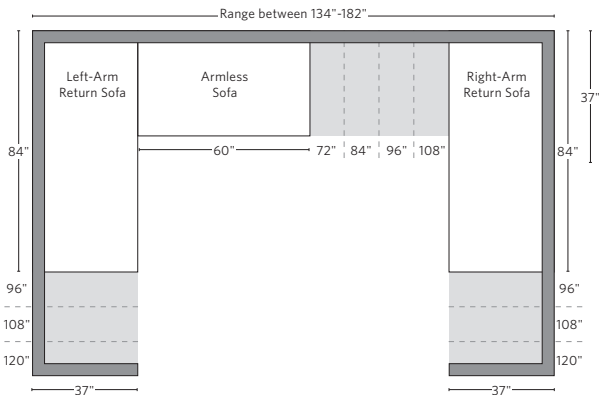

Multiple length options available.

SOFA CHAISE SECTIONAL

Available in left and right-arm configurations.

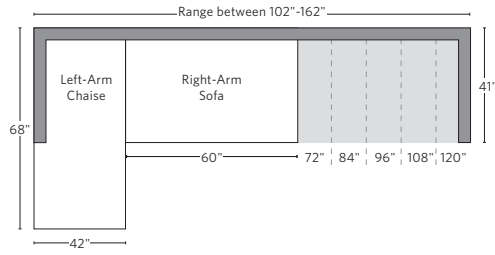

U-CHAISE SECTIONAL

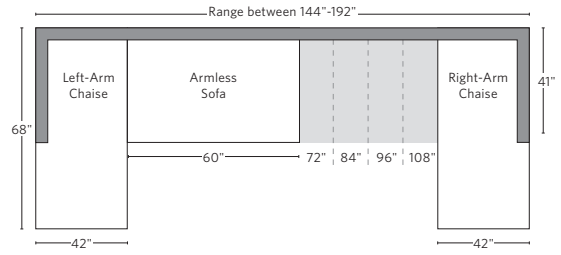

L-SECTIONAL

Available in left and right-arm configurations.

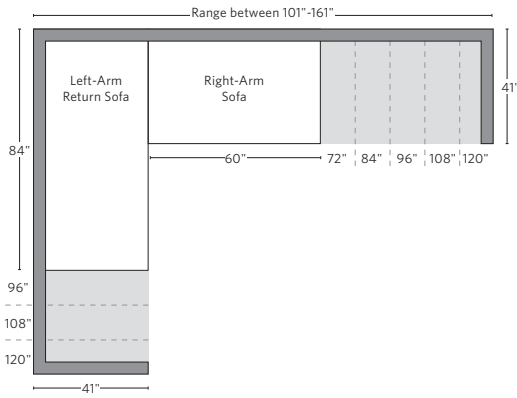

U-SOFA CHAISE SECTIONAL

Available in left and right-arm configurations.

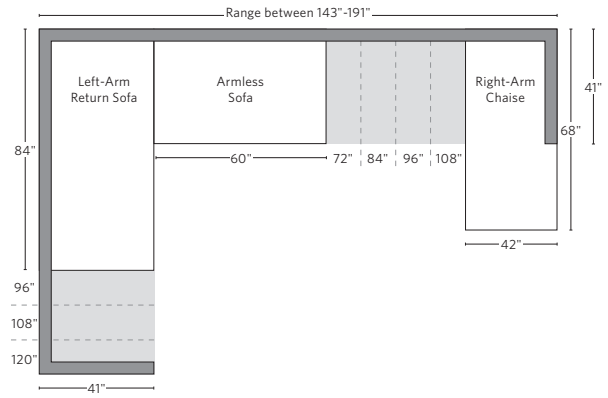

U-SOFA SECTIONAL

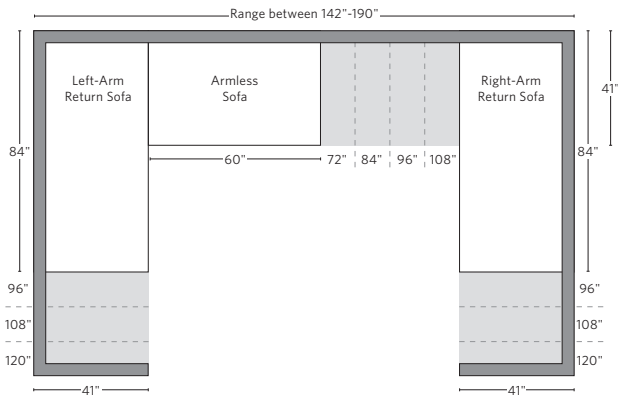

Multiple length options available.

SOFA CHAISE SECTIONAL

Available in left and right-arm configurations.

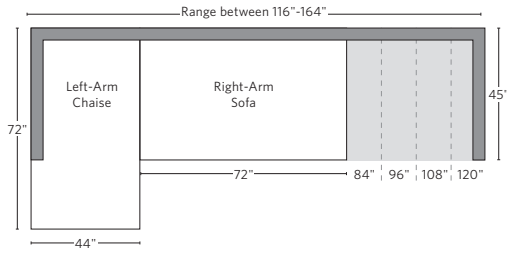

U-CHAISE SECTIONAL

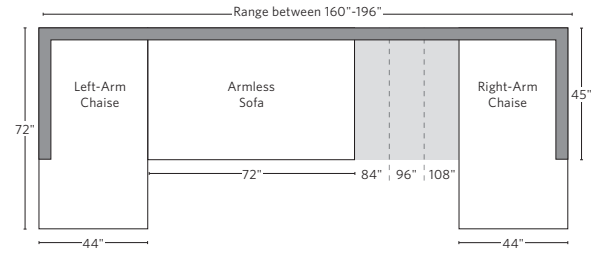

L-SECTIONAL

Available in left and right-arm configurations.

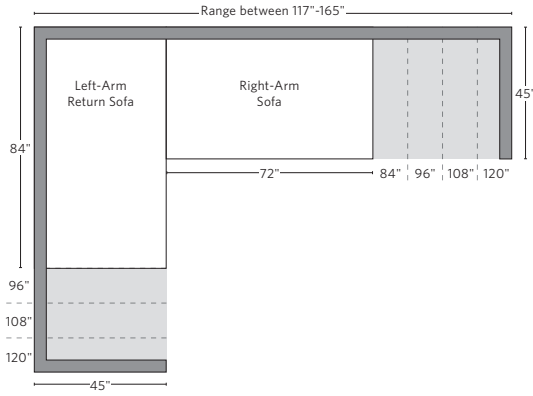

U-SOFA CHAISE SECTIONAL

Available in left and right-arm configurations.

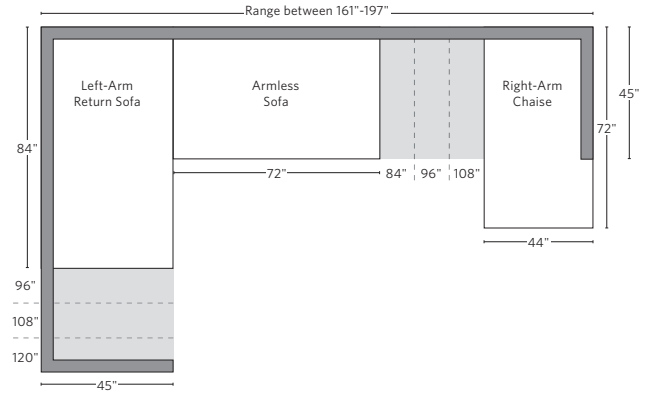

U-SOFA SECTIONAL

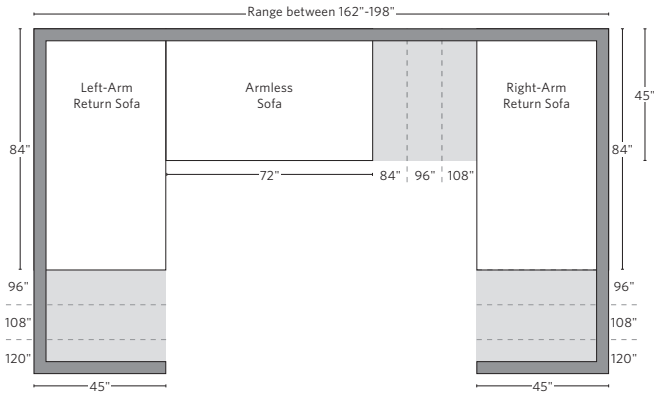

Multiple length options available.