

# BELGIAN CLASSIC SLOPE ARM COLLECTION



All dimensions are given in inches. See the attached "Dimensions Diagram" sheet for more information on the keys used in this chart.

	A	B	C	D	E	F	G	H	I	J	K	L		M	N				O	P	Q	R	S
	OVERALL WIDTH	OVERALL DEPTH	OVERALL HEIGHT	FRAME HEIGHT	SEAT HEIGHT	ARM HEIGHT	FOOT HEIGHT	SEAT HEIGHT (FLOOR TO CUSHION SEAM)	SEAT HEIGHT (FLOOR TO FRAME)	INSIDE SEAT WIDTH	INSIDE SEAT DEPTH W/ BACK CUSHION	INSIDE SEAT DEPTH W/O BACK CUSHION	INSIDE BACK HEIGHT W/ SEAT & BACK CUSHIONS	INSIDE BACK HEIGHT W/ SEAT CUSHION	INSIDE BACK HEIGHT W/O SEAT OR BACK CUSHION	# OF BACK CUSHIONS	# OF SEAT CUSHIONS	ACCENT PILLOWS	ARM HEIGHT W/ SEAT CUSHION	ARM HEIGHT W/O SEAT CUSHION	ARM WIDTH	SLEEPER DEPTH OVERALL	SLEEPER DEPTH INSIDE
5' PETITE SOFA	60	34	28	28	16½	21½	2	15	10	52½	20	27	11½	11½	18	1	1	-	6½	11½	3¾	-	-
5' CLASSIC SOFA	60	38	32	30	19	23	2	18	12	50	21	31	13	11	18	1	1	-	4	11	5	-	-
5' LUXE SOFA	60	43	33	31	19	23	2	18	12	50	27	36	14	12	19	1	1	-	4	11	5	-	-
6' PETITE SOFA	72	34	28	28	16½	21½	2	15	10	64½	20	27	11½	11½	18	2	1	-	6½	11½	3¾	-	-
6' CLASSIC SOFA	72	38	32	30	19	23	2	18	12	62	21	31	13	11	18	2	1	2	4	11	5	-	-
6' CLASSIC SOFA (2 CUSHION)	72	38	32	30	19	23	2	18	12	62	21	31	13	11	18	2	2	2	4	11	5	-	-
6' LUXE SOFA	72	43	33	31	19	23	2	18	12	62	27	36	14	12	19	2	1	2	4	11	5	-	-
6' LUXE SOFA (2 CUSHION)	72	43	33	31	19	23	2	18	12	62	27	36	14	12	19	2	2	2	4	11	5	-	-
7' PETITE SOFA	84	34	28	28	16½	21½	2	15	10	76½	20	27	11½	11½	18	2	1	-	6½	11½	3¾	-	-
7' CLASSIC SOFA	84	38	32	30	19	23	2	18	12	74	21	31	13	11	18	2	1	2	4	11	5	-	-
7' CLASSIC SOFA (2 CUSHION)	84	38	32	30	19	23	2	18	12	74	21	31	13	11	18	2	2	2	4	11	5	-	-
7' LUXE SOFA	84	43	33	31	19	23	2	18	12	74	27	36	14	12	19	2	1	2	4	11	5	-	-
7' LUXE SOFA (2 CUSHION)	84	43	33	31	19	23	2	18	12	74	27	36	14	12	19	2	2	2	4	11	5	-	-
7' LUXE SLEEPER SOFA	84	43	33	31	19	23	2	18	12	74	27	36	14	12	19	2	1	2	4	11	5	88½	61

# BELGIAN CLASSIC SLOPE ARM COLLECTION



All dimensions are given in inches. See the attached "Dimensions Diagram" sheet for more information on the keys used in this chart.

	A	B	C	D	E	F	G	H	I	J	K	L		M	N				O	P	Q	R	S
	OVERALL WIDTH	OVERALL DEPTH	OVERALL HEIGHT	FRAME HEIGHT	SEAT HEIGHT	ARM HEIGHT	FOOT HEIGHT	SEAT HEIGHT (FLOOR TO CUSHION SEAM)	SEAT HEIGHT (FLOOR TO FRAME)	INSIDE SEAT WIDTH	INSIDE SEAT DEPTH W/ BACK CUSHION	INSIDE SEAT DEPTH W/O BACK CUSHION	INSIDE BACK HEIGHT W/ SEAT & BACK CUSHIONS	INSIDE BACK HEIGHT W/ SEAT CUSHION	INSIDE BACK HEIGHT W/O SEAT OR BACK CUSHION	# OF BACK CUSHIONS	# OF SEAT CUSHIONS	ACCENT PILLOWS	ARM HEIGHT W/ SEAT CUSHION	ARM HEIGHT W/O SEAT CUSHION	ARM WIDTH	SLEEPER DEPTH OVERALL	SLEEPER DEPTH INSIDE
8' PETITE SOFA	96	34	28	28	16½	21½	2	15	10	88½	20	27	11½	11½	18	2	1	-	6½	11½	3¾	-	-
8' CLASSIC SOFA	96	38	32	30	19	23	2	18	12	86	21	31	13	11	18	2	1	2	4	11	5	-	-
8' CLASSIC SOFA (2 CUSHION)	96	38	32	30	19	23	2	18	12	86	21	31	13	11	18	2	2	2	4	11	5	-	-
8' LUXE SOFA	96	43	33	31	19	23	2	18	12	86	27	36	14	12	19	2	1	2	4	11	5	-	-
8' LUXE SOFA (2 CUSHION)	96	43	33	31	19	23	2	18	12	86	27	36	14	12	19	2	2	2	4	11	5	-	-
8' LUXE SLEEPER SOFA	96	43	33	31	19	23	2	18	12	86	27	36	14	12	19	2	1	2	4	11	5	88½	61
9' PETITE SOFA	108	34	28	28	16½	21½	2	15	10	100½	20	27	11½	11½	18	2	1	-	6½	11½	3¾	-	-
9' CLASSIC SOFA	108	38	32	30	19	23	2	18	12	98	21	31	13	11	18	2	1	2	4	11	5	-	-
9' CLASSIC SOFA (2 CUSHION)	108	38	32	30	19	23	2	18	12	98	21	31	13	11	18	2	2	2	4	11	5	-	-
9' LUXE SOFA	108	43	33	31	19	23	2	18	12	98	27	36	14	12	19	2	1	2	4	11	5	-	-
9' LUXE SOFA (2 CUSHION)	108	43	33	31	19	23	2	18	12	98	27	36	14	12	19	2	2	2	4	11	5	-	-
10' PETITE SOFA	120	34	28	28	16½	21½	2	15	10	112½	20	27	11½	11½	18	2	1	-	6½	11½	3¾	-	-
10' CLASSIC SOFA	120	38	32	30	19	23	2	18	12	110	21	31	13	11	18	2	1	2	4	11	5	-	-
10' CLASSIC SOFA (2 CUSHION)	120	38	32	30	19	23	2	18	12	110	21	31	13	11	18	2	2	2	4	11	5	-	-

# BELGIAN CLASSIC SLOPE ARM COLLECTION



All dimensions are given in inches. See the attached "Dimensions Diagram" sheet for more information on the keys used in this chart.

	A	B	C	D	E	F	G	H	I	J	K	L	M	N				O	P	Q	R	S	
	OVERALL WIDTH	OVERALL DEPTH	OVERALL HEIGHT	FRAME HEIGHT	SEAT HEIGHT	ARM HEIGHT	FOOT HEIGHT	SEAT HEIGHT (FLOOR TO CUSHION SEAM)	SEAT HEIGHT (FLOOR TO FRAME)	INSIDE SEAT WIDTH	INSIDE SEAT DEPTH W/ BACK CUSHION	INSIDE SEAT DEPTH W/O BACK CUSHION	INSIDE BACK HEIGHT W/ SEAT & BACK CUSHIONS	INSIDE BACK HEIGHT W/ SEAT CUSHION	INSIDE BACK HEIGHT W/O SEAT OR BACK CUSHION	# OF BACK CUSHIONS	# OF SEAT CUSHIONS	ACCENT PILLOWS	ARM HEIGHT W/ SEAT CUSHION	ARM HEIGHT W/O SEAT CUSHION	ARM WIDTH	SLEEPER DEPTH OVERALL	SLEEPER DEPTH INSIDE
10' LUXE SOFA	120	43	33	31	19	23	2	18	12	110	27	36	14	12	19	2	1	2	4	11	5	-	-
10' LUXE SOFA (2 CUSHION)	120	43	33	31	19	23	2	18	12	110	27	36	14	12	19	2	2	2	4	11	5	-	-
PETTE CHAIR	31	34	28	28	16½	21½	2	15	10	23½	20	27	11½	11½	18	1	1	-	6½	11½	3¾	-	-
CLASSIC CHAIR	35	38	32	30	19	23	2	18	12	25	21	31	13	11	18	1	1	1	4	11	5	-	-
LUXE CHAIR	39	43	33	31	19	23	2	18	12	29	27	36	14	12	19	1	1	1	4	11	5	-	-
PETTE CHAIR-AND-A-HALF	50	34	28	28	16½	21½	2	15	10	42½	20	27	11½	11½	18	1	1	-	6½	11½	3¾	-	-
CLASSIC CHAIR-AND-A-HALF	50	38	32	30	19	23	2	18	12	40	21	31	13	11	18	1	1	1	4	11	5	-	-
LUXE CHAIR-AND-A-HALF	50	43	33	31	19	23	2	18	12	40	27	36	14	12	19	1	1	1	4	11	5	-	-
CLASSIC SWIVEL CHAIR	35	38	32	30	19	23	-	18	12	25	21	31	13	11	18	1	1	1	4	11	5	-	-
LUXE SWIVEL CHAIR	39	43	33	31	19	23	-	18	12	29	27	36	14	12	19	1	1	1	4	11	5	-	-
CHAISE	39	72	33	31	19	23	2	18	12	29	56	65	14	12	19	1	1	-	4	11	5	-	-
DAYBED	96	60	33	31	19	23	2	18	12	86	44	53	14	12	19	2	1	2	4	11	5	-	-
PETTE OTTOMAN	31	31	16	16	16	-	2	15	10	31	-	-	-	-	-	-	1	-	-	-	-	-	-
OTTOMAN	40	33	20	20	20	-	2	19	12	40	-	-	-	-	-	-	1	-	-	-	-	-	-

# BELGIAN CLASSIC SLOPE ARM COLLECTION



All dimensions are given in inches. See the attached "Dimensions Diagram" sheet for more information on the keys used in this chart.

	OVERALL WIDTH A	OVERALL DEPTH B	OVERALL HEIGHT C	FRAME HEIGHT D	SEAT HEIGHT E	ARM HEIGHT F	FOOT HEIGHT G	SEAT HEIGHT (FLOOR TO CUSHION SEAM) H	SEAT HEIGHT (FLOOR TO FRAME) I	INSIDE SEAT WIDTH J	INSIDE SEAT DEPTH W/ BACK CUSHION K	INSIDE SEAT DEPTH W/O BACK CUSHION L	INSIDE BACK HEIGHT W/ SEAT & BACK CUSHIONS M	INSIDE BACK HEIGHT W/ SEAT CUSHION N	# OF BACK CUSHIONS	# OF SEAT CUSHIONS	ACCENT PILLOWS	ARM HEIGHT W/ SEAT CUSHION O	ARM HEIGHT W/O SEAT CUSHION P	ARM WIDTH Q	SLEEPER DEPTH OVERALL R	SLEEPER DEPTH INSIDE S	
5' PETITE ARMLESS SOFA	60	34	28	28	16½	-	2	15	10	60	20	27	11½	11½	18	2	1	-	-	-	-	-	-
5' CLASSIC ARMLESS SOFA	60	38	32	30	19	-	2	18	12	60	21	31	13	11	18	2	1	-	-	-	-	-	-
6' PETITE ARMLESS SOFA	72	34	28	28	16½	-	2	15	10	72	20	27	11½	11½	18	2	1	-	-	-	-	-	-
6' CLASSIC ARMLESS SOFA	72	38	32	30	19	-	2	18	12	72	21	31	13	11	18	2	1	-	-	-	-	-	-
6' LUXE ARMLESS SOFA	72	43	33	31	19	-	2	18	12	72	27	36	14	12	19	2	1	-	-	-	-	-	-
7' PETITE ARMLESS SOFA	84	34	28	28	16½	-	2	15	10	84	20	27	11½	11½	18	2	1	-	-	-	-	-	-
7' CLASSIC ARMLESS SOFA	84	38	32	30	19	-	2	18	12	84	21	31	13	11	18	2	1	-	-	-	-	-	-
7' LUXE ARMLESS SOFA	84	43	33	31	19	-	2	18	12	84	27	36	14	12	19	2	1	-	-	-	-	-	-
8' PETITE ARMLESS SOFA	96	34	28	28	16½	-	2	15	10	96	20	27	11½	11½	18	2	1	-	-	-	-	-	-
8' CLASSIC ARMLESS SOFA	96	38	32	30	19	-	2	18	12	96	21	31	13	11	18	2	1	-	-	-	-	-	-
8' LUXE ARMLESS SOFA	96	43	33	31	19	-	2	18	12	96	27	36	14	12	19	2	1	-	-	-	-	-	-
9' PETITE ARMLESS SOFA	108	34	28	28	16½	-	2	15	10	108	20	27	11½	11½	18	2	1	-	-	-	-	-	-
9' CLASSIC ARMLESS SOFA	108	38	32	30	19	-	2	18	12	108	21	31	13	11	18	2	1	-	-	-	-	-	-
9' LUXE ARMLESS SOFA	108	43	33	31	19	-	2	18	12	108	27	36	14	12	19	2	1	-	-	-	-	-	-

# BELGIAN CLASSIC SLOPE ARM COLLECTION



All dimensions are given in inches. See the attached "Dimensions Diagram" sheet for more information on the keys used in this chart.

	A	B	C	D	E	F	G	H	I	J	K	L		M	N				O	P	Q	R	S
	OVERALL WIDTH	OVERALL DEPTH	OVERALL HEIGHT	FRAME HEIGHT	SEAT HEIGHT	ARM HEIGHT	FOOT HEIGHT	SEAT HEIGHT (FLOOR TO CUSHION SEAM)	SEAT HEIGHT (FLOOR TO FRAME)	INSIDE SEAT WIDTH	INSIDE SEAT DEPTH W/ BACK CUSHION	INSIDE SEAT DEPTH W/O BACK CUSHION	INSIDE BACK HEIGHT W/ SEAT & BACK CUSHIONS	INSIDE BACK HEIGHT W/ SEAT CUSHION	INSIDE BACK HEIGHT W/O SEAT OR BACK CUSHION	# OF BACK CUSHIONS	# OF SEAT CUSHIONS	ACCENT PILLOWS	ARM HEIGHT W/ SEAT CUSHION	ARM HEIGHT W/O SEAT CUSHION	ARM WIDTH	SLEEPER DEPTH OVERALL	SLEEPER DEPTH INSIDE
10' LUXE ARMLESS SOFA	120	43	33	31	19	-	2	18	12	120	27	36	14	12	19	2	1	-	-	-	-	-	-
5' PETITE LEFT-ARM SOFA	60	34	28	28	16½	21½	2	15	10	56¾	20	27	11½	11½	18	2	1	-	6½	11½	3¾	-	-
5' PETITE RIGHT-ARM SOFA	60	34	28	28	16½	21½	2	15	10	56¾	20	27	11½	11½	18	2	1	-	6½	11½	3¾	-	-
5' CLASSIC LEFT-ARM SOFA	60	38	32	30	19	23	2	18	12	55	21	31	13	11	18	2	1	-	4	11	5	-	-
5' CLASSIC RIGHT-ARM SOFA	60	38	32	30	19	23	2	18	12	55	21	31	13	11	18	2	1	-	4	11	5	-	-
6' PETITE LEFT-ARM SOFA	72	34	28	28	16½	21½	2	15	10	68¾	20	27	11½	11½	18	2	1	-	6½	11½	3¾	-	-
6' PETITE RIGHT-ARM SOFA	72	34	28	28	16½	21½	2	15	10	68¾	20	27	11½	11½	18	2	1	-	6½	11½	3¾	-	-
6' CLASSIC LEFT-ARM SOFA	72	38	32	30	19	23	2	18	12	67	21	31	13	11	18	2	1	-	4	11	5	-	-
6' CLASSIC RIGHT-ARM SOFA	72	38	32	30	19	23	2	18	12	67	21	31	13	11	18	2	1	-	4	11	5	-	-
6' LUXE LEFT-ARM SOFA	72	43	33	31	19	23	2	18	12	67	27	36	14	12	19	2	1	-	4	11	5	-	-
6' LUXE RIGHT-ARM SOFA	72	43	33	31	19	23	2	18	12	67	27	36	14	12	19	2	1	-	4	11	5	-	-
7' PETITE LEFT-ARM SOFA	84	34	28	28	16½	21½	2	15	10	80¾	20	27	11½	11½	18	2	1	-	6½	11½	3¾	-	-
7' PETITE RIGHT-ARM SOFA	84	34	28	28	16½	21½	2	15	10	80¾	20	27	11½	11½	18	2	1	-	6½	11½	3¾	-	-
7' CLASSIC LEFT-ARM SOFA	84	38	32	30	19	23	2	18	12	79	21	31	13	11	18	2	1	-	4	11	5	-	-

# BELGIAN CLASSIC SLOPE ARM COLLECTION



All dimensions are given in inches. See the attached "Dimensions Diagram" sheet for more information on the keys used in this chart.

	A	B	C	D	E	F	G	H	I	J	K	L		M	N				O	P	Q	R	S
	OVERALL WIDTH	OVERALL DEPTH	OVERALL HEIGHT	FRAME HEIGHT	SEAT HEIGHT	ARM HEIGHT	FOOT HEIGHT	SEAT HEIGHT (FLOOR TO CUSHION SEAM)	SEAT HEIGHT (FLOOR TO FRAME)	INSIDE SEAT WIDTH	INSIDE SEAT DEPTH W/ BACK CUSHION	INSIDE SEAT DEPTH W/O BACK CUSHION	INSIDE BACK HEIGHT W/ SEAT & BACK CUSHIONS	INSIDE BACK HEIGHT W/ SEAT CUSHION	INSIDE BACK HEIGHT W/O SEAT OR BACK CUSHION	# OF BACK CUSHIONS	# OF SEAT CUSHIONS	ACCENT PILLOWS	ARM HEIGHT W/ SEAT CUSHION	ARM HEIGHT W/O SEAT CUSHION	ARM WIDTH	SLEEPER DEPTH OVERALL	SLEEPER DEPTH INSIDE
7' CLASSIC RIGHT-ARM SOFA	84	38	32	30	19	23	2	18	12	79	21	31	13	11	18	2	1	-	4	11	5	-	-
7' LUXE LEFT-ARM SOFA	84	43	33	31	19	23	2	18	12	79	27	36	14	12	19	2	1	-	4	11	5	-	-
7' LUXE RIGHT-ARM SOFA	84	43	33	31	19	23	2	18	12	79	27	36	14	12	19	2	1	-	4	11	5	-	-
8' PETITE LEFT-ARM SOFA	96	34	28	28	16½	21½	2	15	10	92¼	20	27	11½	11½	18	2	1	-	6½	11½	3¾	-	-
8' PETITE RIGHT-ARM SOFA	96	34	28	28	16½	21½	2	15	10	92¼	20	27	11½	11½	18	2	1	-	6½	11½	3¾	-	-
8' CLASSIC LEFT-ARM SOFA	96	38	32	30	19	23	2	18	12	91	21	31	13	11	18	2	1	-	4	11	5	-	-
8' CLASSIC RIGHT-ARM SOFA	96	38	32	30	19	23	2	18	12	91	21	31	13	11	18	2	1	-	4	11	5	-	-
8' LUXE LEFT-ARM SOFA	96	43	33	31	19	23	2	18	12	91	27	36	14	12	19	2	1	-	4	11	5	-	-
8' LUXE RIGHT-ARM SOFA	96	43	33	31	19	23	2	18	12	91	27	36	14	12	19	2	1	-	4	11	5	-	-
9' PETITE LEFT-ARM SOFA	108	34	28	28	16½	21½	2	15	10	104¼	20	27	11½	11½	18	2	1	-	6½	11½	3¾	-	-
9' PETITE RIGHT-ARM SOFA	108	34	28	28	16½	21½	2	15	10	104¼	20	27	11½	11½	18	2	1	-	6½	11½	3¾	-	-
9' CLASSIC LEFT-ARM SOFA	108	38	32	30	19	23	2	18	12	103	21	31	13	11	18	2	1	-	4	11	5	-	-
9' CLASSIC RIGHT-ARM SOFA	108	38	32	30	19	23	2	18	12	103	21	31	13	11	18	2	1	-	4	11	5	-	-
9' LUXE LEFT-ARM SOFA	108	43	33	31	19	23	2	18	12	103	27	36	14	12	19	2	1	-	4	11	5	-	-

# BELGIAN CLASSIC SLOPE ARM COLLECTION



All dimensions are given in inches. See the attached "Dimensions Diagram" sheet for more information on the keys used in this chart.

	A	B	C	D	E	F	G	H	I	J	K	L		M	N				O	P	Q	R	S
	OVERALL WIDTH	OVERALL DEPTH	OVERALL HEIGHT	FRAME HEIGHT	SEAT HEIGHT	ARM HEIGHT	FOOT HEIGHT	SEAT HEIGHT (FLOOR TO CUSHION SEAM)	SEAT HEIGHT (FLOOR TO FRAME)	INSIDE SEAT WIDTH	INSIDE SEAT DEPTH W/ BACK CUSHION	INSIDE SEAT DEPTH W/O BACK CUSHION	INSIDE BACK HEIGHT W/ SEAT & BACK CUSHIONS	INSIDE BACK HEIGHT W/ SEAT CUSHION	INSIDE BACK HEIGHT W/O SEAT OR BACK CUSHION	# OF BACK CUSHIONS	# OF SEAT CUSHIONS	ACCENT PILLOWS	ARM HEIGHT W/ SEAT CUSHION	ARM HEIGHT W/O SEAT CUSHION	ARM WIDTH	SLEEPER DEPTH OVERALL	SLEEPER DEPTH INSIDE
9' LUXE RIGHT-ARM SOFA	108	43	33	31	19	23	2	18	12	103	27	36	14	12	19	2	1	-	4	11	5	-	-
10' LUXE LEFT-ARM SOFA	120	43	33	31	19	23	2	18	12	115	27	36	14	12	19	2	1	-	4	11	5	-	-
10' LUXE RIGHT-ARM SOFA	120	43	33	31	19	23	2	18	12	115	27	36	14	12	19	2	1	-	4	11	5	-	-
7' PETITE LEFT-ARM RETURN SOFA	84	34	28	28	16½	21½	2	15	10	74	20	27	11½	11½	18	4	1	-	6½	11½	3¾	-	-
7' PETITE RIGHT-ARM RETURN SOFA	84	34	28	28	16½	21½	2	15	10	74	20	27	11½	11½	18	4	1	-	6½	11½	3¾	-	-
7' CLASSIC LEFT-ARM RETURN SOFA	84	38	32	30	19	23	2	18	12	72	21	31	13	11	18	3	1	-	4	11	5	-	-
7' CLASSIC RIGHT-ARM RETURN SOFA	84	38	32	30	19	23	2	18	12	72	21	31	13	11	18	3	1	-	4	11	5	-	-
7' LUXE LEFT-ARM RETURN SOFA	84	43	33	31	19	23	2	18	12	72	27	36	14	12	19	3	1	-	4	11	5	-	-
7' LUXE RIGHT-ARM RETURN SOFA	84	43	33	31	19	23	2	18	12	72	27	36	14	12	19	3	1	-	4	11	5	-	-
8' PETITE LEFT-ARM RETURN SOFA	96	34	28	28	16½	21½	2	15	10	86	20	27	11½	11½	18	4	1	-	6½	11½	3¾	-	-
8' PETITE RIGHT-ARM RETURN SOFA	96	34	28	28	16½	21½	2	15	10	86	20	27	11½	11½	18	4	1	-	6½	11½	3¾	-	-
8' CLASSIC LEFT-ARM RETURN SOFA	96	38	32	30	19	23	2	18	12	84	21	31	13	11	18	3	1	-	4	11	5	-	-
8' CLASSIC RIGHT-ARM RETURN SOFA	96	38	32	30	19	23	2	18	12	84	21	31	13	11	18	3	1	-	4	11	5	-	-
8' LUXE LEFT-ARM RETURN SOFA	96	43	33	31	19	23	2	18	12	84	27	36	14	12	19	3	1	-	4	11	5	-	-

# BELGIAN CLASSIC SLOPE ARM COLLECTION



All dimensions are given in inches. See the attached "Dimensions Diagram" sheet for more information on the keys used in this chart.

	OVERALL WIDTH A	OVERALL DEPTH B	OVERALL HEIGHT C	FRAME HEIGHT D	SEAT HEIGHT E	ARM HEIGHT F	FOOT HEIGHT G	SEAT HEIGHT (FLOOR TO CUSHION SEAM) H	SEAT HEIGHT (FLOOR TO FRAME) I	INSIDE SEAT WIDTH J	INSIDE SEAT DEPTH W/ BACK CUSHION K	INSIDE SEAT DEPTH W/O BACK CUSHION L	INSIDE BACK HEIGHT W/ SEAT & BACK CUSHIONS M	INSIDE BACK HEIGHT W/ SEAT CUSHION N	# OF BACK CUSHIONS	# OF SEAT CUSHIONS	ACCENT PILLOWS	ARM HEIGHT W/ SEAT CUSHION O	ARM HEIGHT W/O SEAT CUSHION P	ARM WIDTH Q	SLEEPER DEPTH OVERALL R	SLEEPER DEPTH INSIDE S	
8' LUXE RIGHT-ARM RETURN SOFA	96	43	33	31	19	23	2	18	12	84	27	36	14	12	19	3	1	-	4	11	5	-	-
9' PETITE LEFT-ARM RETURN SOFA	108	34	28	28	16½	21½	2	15	10	98	20	27	11½	11½	18	4	1	-	6½	11½	3¾	-	-
9' PETITE RIGHT-ARM RETURN SOFA	108	34	28	28	16½	21½	2	15	10	98	20	27	11½	11½	18	4	1	-	6½	11½	3¾	-	-
9' CLASSIC LEFT-ARM RETURN SOFA	108	38	32	30	19	23	2	18	12	96	21	31	13	11	18	3	1	-	4	11	5	-	-
9' CLASSIC RIGHT-ARM RETURN SOFA	108	38	32	30	19	23	2	18	12	96	21	31	13	11	18	3	1	-	4	11	5	-	-
9' LUXE LEFT-ARM RETURN SOFA	108	43	33	31	19	23	2	18	12	96	27	36	14	12	19	3	1	-	4	11	5	-	-
9' LUXE RIGHT-ARM RETURN SOFA	108	43	33	31	19	23	2	18	12	96	27	36	14	12	19	3	1	-	4	11	5	-	-
10' CLASSIC LEFT-ARM RETURN SOFA	120	38	32	30	19	23	2	18	12	108	21	31	13	11	18	3	1	-	4	11	5	-	-
10' CLASSIC RIGHT-ARM RETURN SOFA	120	38	32	30	19	23	2	18	12	108	21	31	13	11	18	3	1	-	4	11	5	-	-
10' LUXE LEFT-ARM RETURN SOFA	120	43	33	31	19	23	2	18	12	108	27	36	14	12	19	3	1	-	4	11	5	-	-
10' LUXE RIGHT-ARM RETURN SOFA	120	43	33	31	19	23	2	18	12	108	27	36	14	12	19	3	1	-	4	11	5	-	-
PETITE LEFT-ARM CHAISE	28	65	28	28	16½	21½	2	15	10	24¾	51	58	11½	11½	18	1	1	-	6½	11½	3¾	-	-
PETITE RIGHT-ARM CHAISE	28	65	28	28	16½	21½	2	15	10	24¾	51	58	11½	11½	18	1	1	-	6½	11½	3¾	-	-
CLASSIC LEFT-ARM CHAISE	34	71	32	30	19	23	2	18	12	29	55	64	13	11	18	1	1	-	4	11	5	-	-



# BELGIAN CLASSIC SLOPE ARM COLLECTION



All dimensions are given in inches. See the attached "Dimensions Diagram" sheet for more information on the keys used in this chart.

	A	B	C	D	E	F	G	H	I	J	K	L		M	N				O	P	Q	R	S
	OVERALL WIDTH	OVERALL DEPTH	OVERALL HEIGHT	FRAME HEIGHT	SEAT HEIGHT	ARM HEIGHT	FOOT HEIGHT	SEAT HEIGHT (FLOOR TO CUSHION SEAM)	SEAT HEIGHT (FLOOR TO FRAME)	INSIDE SEAT WIDTH	INSIDE SEAT DEPTH W/ BACK CUSHION	INSIDE SEAT DEPTH W/O BACK CUSHION	INSIDE BACK HEIGHT W/ SEAT & BACK CUSHIONS	INSIDE BACK HEIGHT W/ SEAT CUSHION	INSIDE BACK HEIGHT W/O SEAT OR BACK CUSHION	# OF BACK CUSHIONS	# OF SEAT CUSHIONS	ACCENT PILLOWS	ARM HEIGHT W/ SEAT CUSHION	ARM HEIGHT W/O SEAT CUSHION	ARM WIDTH	SLEEPER DEPTH OVERALL	SLEEPER DEPTH INSIDE
CLASSIC RIGHT-ARM CHAISE	34	71	32	30	19	23	2	18	12	29	55	64	13	11	18	1	1	-	4	11	5	-	-
LUXE LEFT-ARM CHAISE	38	74	33	31	19	23	2	18	12	33	58	67	14	12	19	1	1	-	4	11	5	-	-
LUXE RIGHT-ARM CHAISE	38	74	33	31	19	23	2	18	12	33	58	67	14	12	19	1	1	-	4	11	5	-	-

# UPHOLSTERY DIMENSIONS DIAGRAM

See the "Dimensions Sheet" for the measurements that correspond with the letters below.

RH

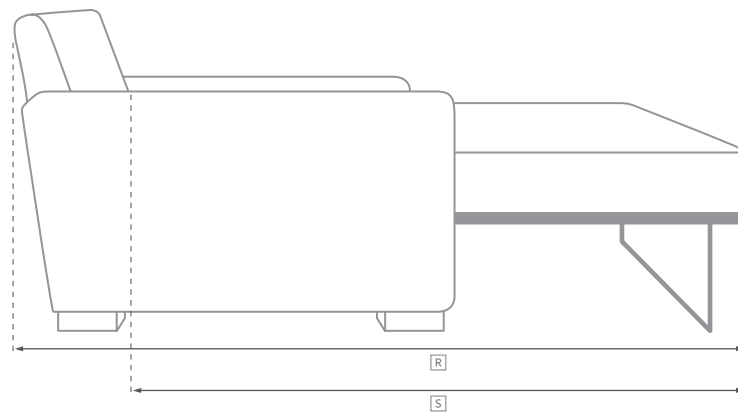
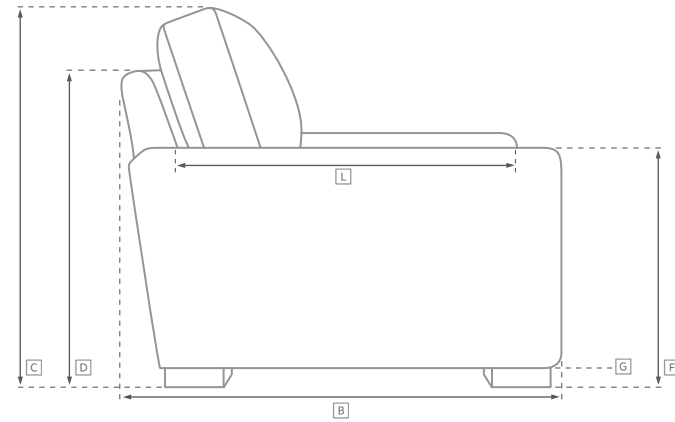
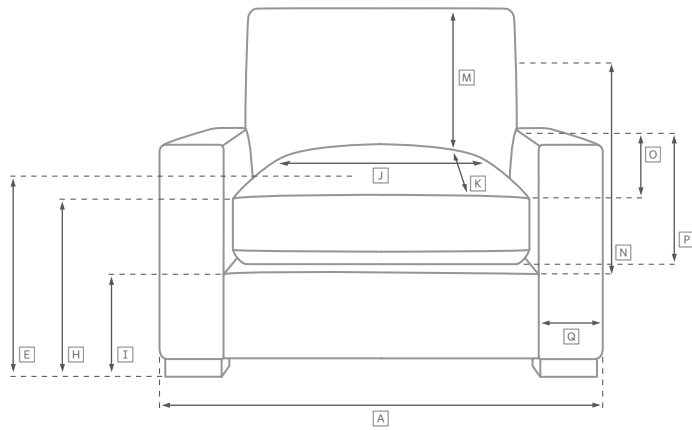

SOFA CHAISE SECTIONAL

Available in left and right-arm configurations.

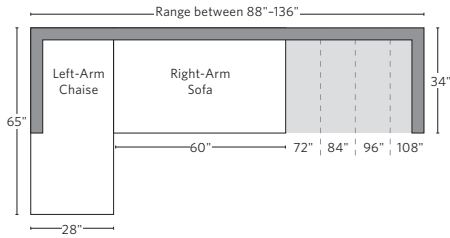

U-CHAISE SECTIONAL

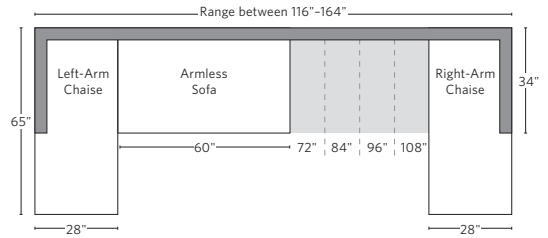

L-SECTIONAL

Available in left and right-arm configurations.

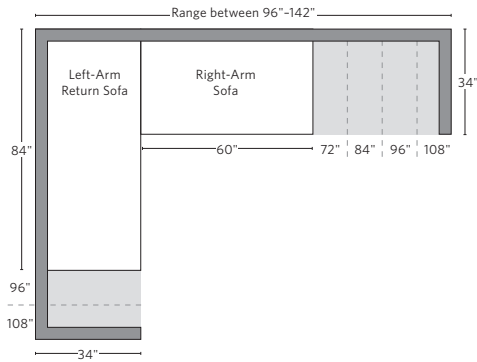

U-SOFA CHAISE SECTIONAL

Available in left and right-arm configurations.

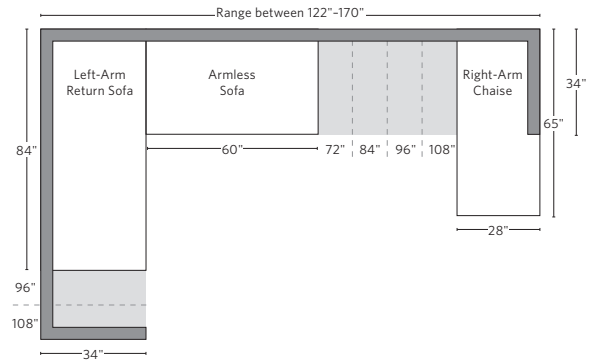

U-SOFA SECTIONAL

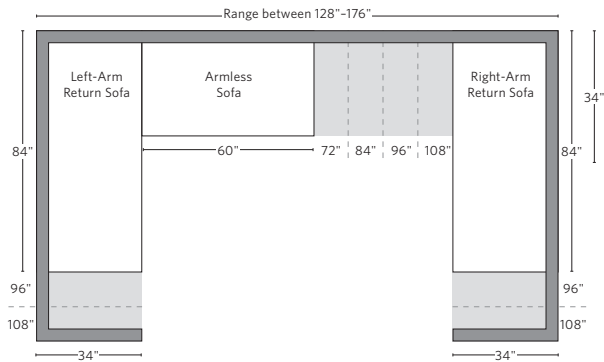

Multiple length options available.

SOFA CHAISE SECTIONAL

Available in left and right-arm configurations.

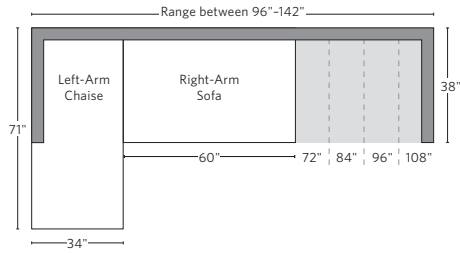

U-CHAISE SECTIONAL

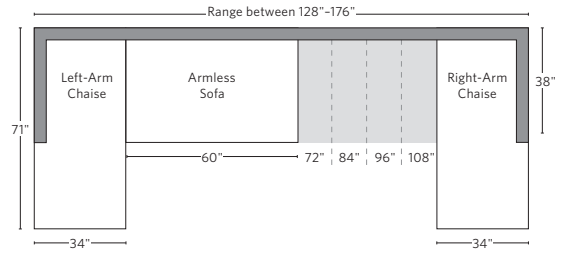

L-SECTIONAL

Available in left and right-arm configurations.

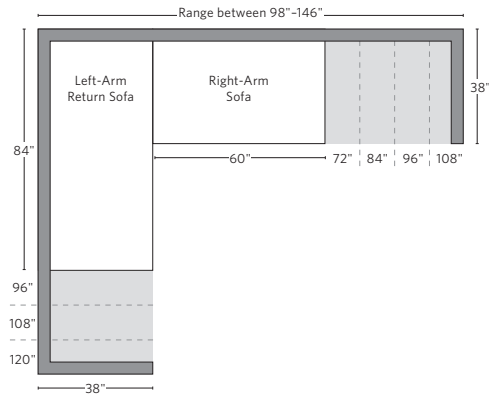

U-SOFA CHAISE SECTIONAL

Available in left and right-arm configurations.

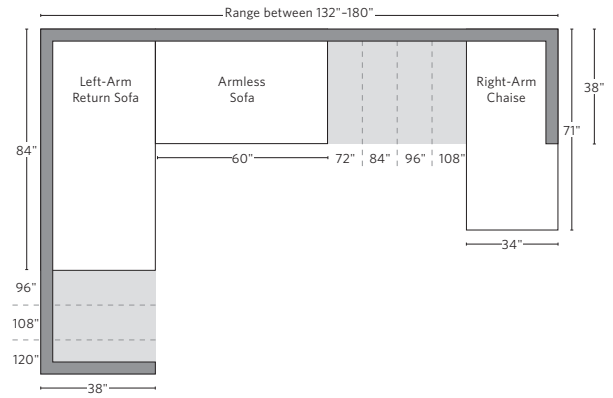

U-SOFA SECTIONAL

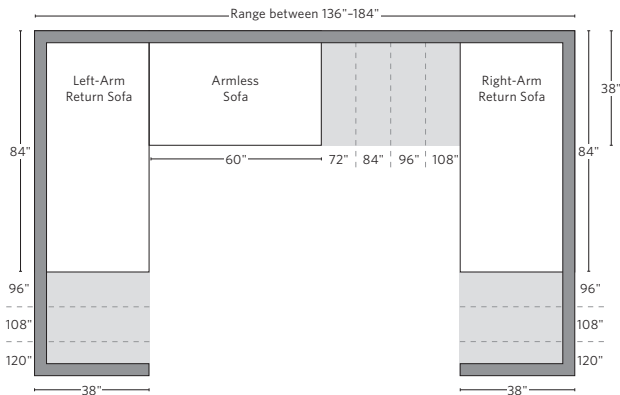

Multiple length options available.

SOFA CHAISE SECTIONAL

Available in left and right-arm configurations.

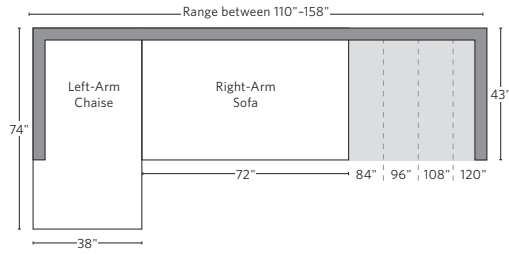

U-CHAISE SECTIONAL

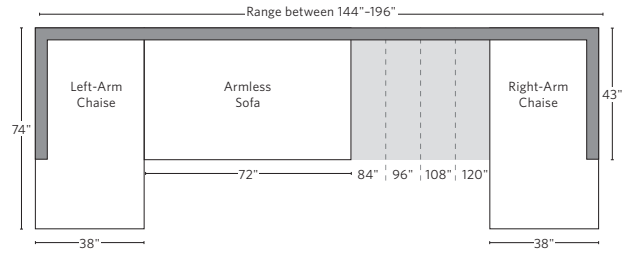

L-SECTIONAL

Available in left and right-arm configurations.

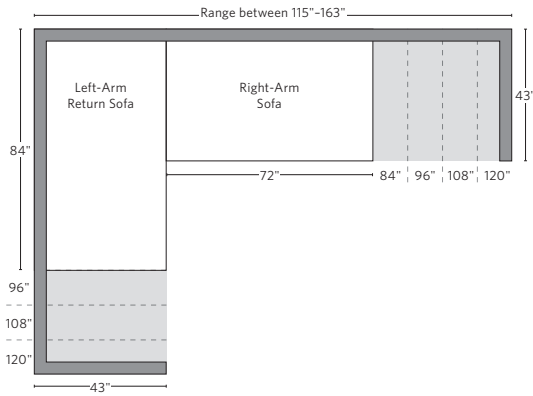

U-SOFA CHAISE SECTIONAL

Available in left and right-arm configurations.

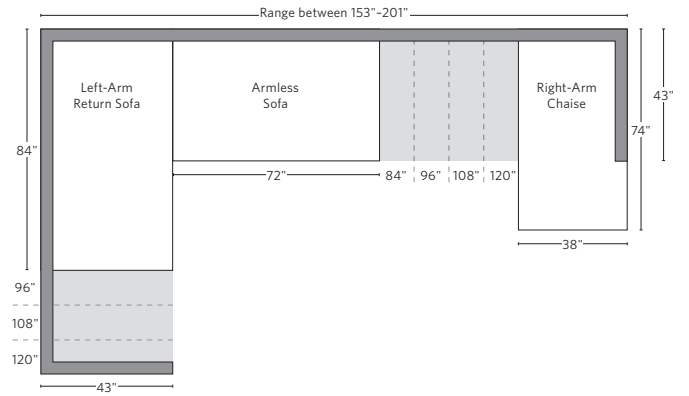

U-SOFA SECTIONAL

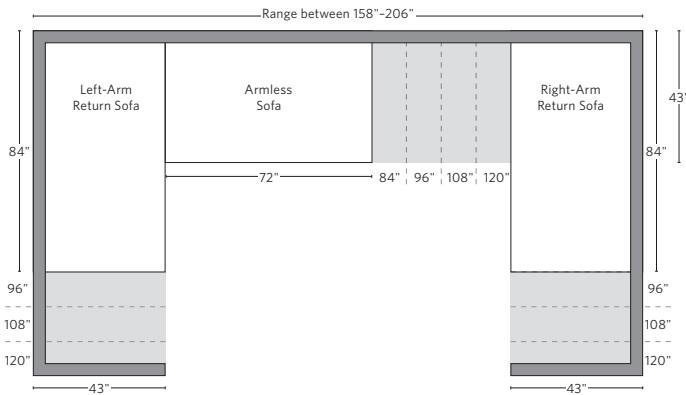

Multiple length options available.