

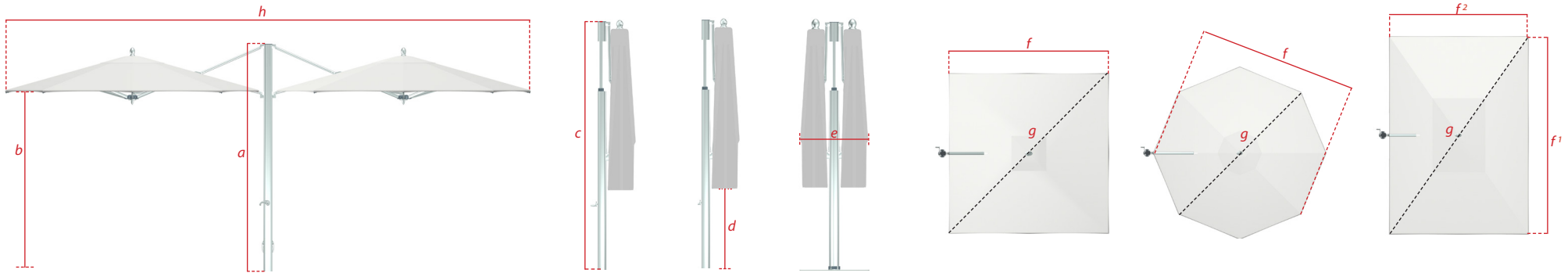

ocean master & plantation MAX dual cantilever

“easy drive” crank w/ telescoping mast

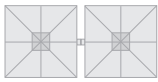
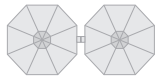

		mast height (open position)	canopy clearance	mast height (telescope closed position)	table clearance (telescope)	closed parasol width (closed include crank handle)	flat to flat	point to point	parasol width end to end (open position)
	sizes [ft/m]	a (in/cm)	b (in/cm)	c (in/cm)	d (in/cm)	e (in/cm)	f (in/cm)	g (in/cm)	h (in/cm)
MAX dual cantilever square 	8.0' x 16.0' 2.4m x 4.9m	102 / 260	87 / 220	123 / 313	53 / 134	42 / 107	96 / 244	134 / 341	206 / 524
	10.0' x 20.0' 3.0m x 6.0m	102 / 260	84 / 213	128 / 326	40 / 101	36 / 92	121 / 308	168 / 427	251 / 638
	12.0' x 24.0' 3.65m x 7.4m	108 / 275	81 / 205	131 / 333	31 / 78	38 / 97	143 / 364	201 / 511	300 / 762
	13.0' x 26.0' 4.0m x 7.9m	112 / 285	91 / 231	145 / 369	31 / 78	41 / 97	153 / 389	215 / 547	318 / 808
octagon 	9.0' x 18.0' 2.75m x 5.4m	102 / 260	84 / 213	128 / 326	63 / 160	44 / 112	103 / 262	110 / 280	232 / 590
	11.0' x 22.0' 3.4m x 6.8m	102 / 260	80 / 203	133 / 337	54 / 137	41 / 105	121 / 308	132 / 336	276 / 702
	13.0' x 26.0' 4.0m x 8.0m	106 / 270	88 / 233	140 / 356	51 / 129	46 / 117	142 / 361	154 / 392	319 / 811
rectangle 	16.0' x 12.0' 4.9m x 3.65m	99 / 252	84.5 / 215	118 / 300	32 / 81	36 / 92	f' X f' 97, 145 / 247, 369	174 / 442	208 / 528
	20.0' x 14.0' 6.0m x 4.25m	106 / 270	89 / 226	130 / 331	28 / 71	34 / 87	f' X f' 120, 171 / 305, 435	209 / 531	252 / 641



Dimension Tolerances ± 2"
 Dimensions shown correspond to indicated lift system
 Options are subject to change without notice
 Some options are only available in certain sizes and shapes

2" security base stem height not included

g-plate anchors

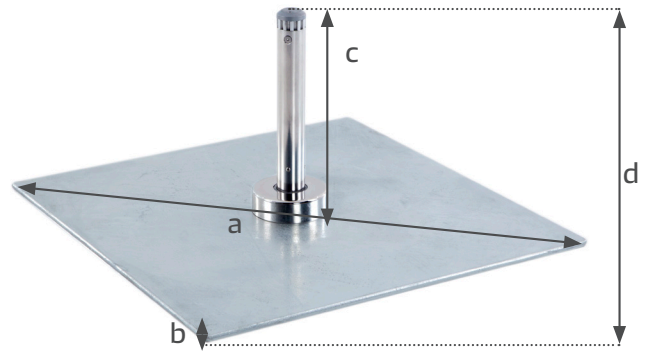
galvanized steel w/ stainless steel security sleeve



base & weight recommendation Tolerances +/- 10 lbs	TUUCI product	umbrella size	a	b	c	d
			base diameter (tolerances +/- 1/2")	g-plate height	security sleeve height	total height
for MAX parasols 400 LBS (181 KG) (2 plates) 	Tuuci® Ocean Master Max Cantilever Umbrella & Tuuci® Ocean Master Max Center-Post Umbrella Tuuci® Bay Master Cantilever Umbrella Tuuci Ocean Master Cantilever Umbrella	10' and below	36.0"	1.0"	17.5"	18.5"
for MAX parasols 600 LBS (272 KG) (3 plates) 	Tuuci® Ocean Master Max and Ocean Master Cantilever Umbrella	Above 10'	36.0"	1.5"	17.5"	19"
	Tuuci® Ocean Master Max Dual Cantilever Umbrella	ALL Dual Cantilever Sizes				
	Tuuci® Ocean Master Max Center-Post Umbrella	Above 10'				

Base weight recommendations vary by wind speed and umbrella size. If more stability is desired, move up to a higher base weight. All umbrellas should be closed in inclement weather or significant wind events. Should not be left open when unattended.