

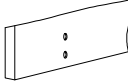









RESTORATION HARDWARE

ODEON CHANDELIER MEDIUM 5 RINGS

PARTS ENCLOSED

ITEMS	DIAGRAM	DESCRIPTION	QTY.
(A)		Wooden Beam (Not included)	—
(B)		Wooden Ceiling Mounting Hardware	1
(C)		Mounting Bolts & nuts (Not included)	1 Set
(D)		Collar	1
(E1)		Canopy	1
(E2)			
(F)		Hang Straight	1
(G)		Quick Link	2
(H)		Chain	1
(I)		Wire Nut	3
(J)		Glass Drop+Spare	205+6
(K)		Bulb+Spare	17+6
(L)		Body	1

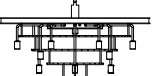
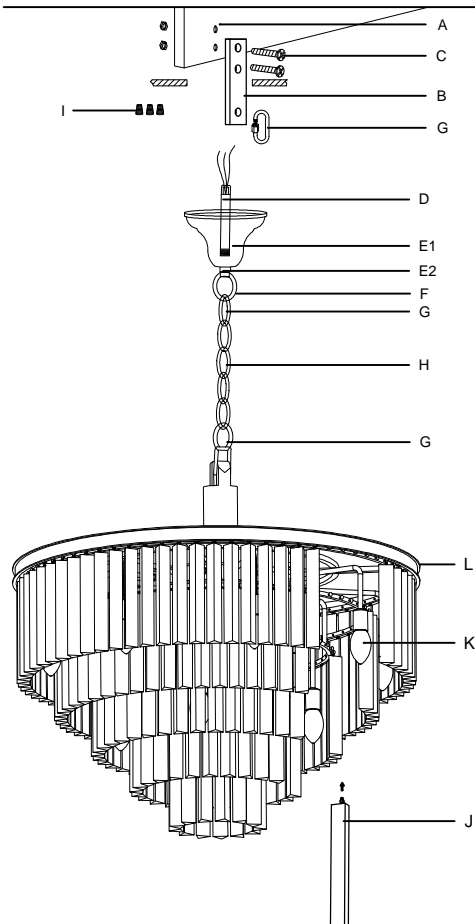

IMPORTANT SAFETY INSTRUCTIONS:

1. Use an authorized and certified electrician for consultation and installation. Electrician must be familiar with commercial-type applications of very heavy chandeliers.
2. This fixture has been rated for 17 x 25-watt maximum E12 standard bulb.
3. To avoid the risk of fire, do not exceed the recommended wattage.
4. The ceiling must have at least the capacity of 5 times the weight of the ceiling light. For this light at least a ceiling capacity of 325kg is required.
5. The manufacturer and distributor accepts no liability for incorrect installation.
6. For indoor use only.
7. Keep away from children.

Warnings:

1. Turn-off electricity supply at main circuit panel before installing. Do not connect electricity supply until your ceiling light is fully assembled and installed.
2. All wires are connected. Do not remove the ceiling light from its packaging by pulling on the power cord, as a bad connection may result.
3. To reduce the risk of fire, electrical shock, or personal injury, always turn off the ceiling light and allow it to cool prior to replacing light bulb. Do not touch bulb when fixture is turned on or look directly at light bulb. Keep flammable materials away from light bulb.
4. Deviation from instructions may result in a risk of fire or electric shock.

PRODUCT DESCRIPTION:

General material: Glass & Iron
 Height: 66.0 cm
 Diameter: 80.0 cm
 Weight: 65.0 kg
 Grounded / Hardwired

TO ASSEMBLE:

1. Carefully remove all parts from the box and remove all plastic covering.
2. Turn OFF power to the junction box where the ceiling light will be installed.
3. Loosen the bolt of hang straight (F) and remove the collar (D) from the hang straight (F) by unscrewing it. Then insert (D) into canopy (E1) and re-attach collar (D) to hang straight (F). Tighten the bolt of the hang straight (F).
4. Unlock the quick link (G) at the opposite end of the chain (H) to attach the chandelier body (L).
5. Attach the wooden ceiling mounting hardware (B) to the wooden beam (A) with mounting bolts and nuts (C).
6. Attach end of the collar (D) to the wooden ceiling mounting hardware (B) with quick link (G).
7. Connect the ground wire from the fixture to the ground junction box wire (Usually the green or bare wire) with a wire nut (I) and wrap the connection with electrical tape. Connect the hot wire to the hot junction box wire (Usually black or smooth) with a plastic wire nut (I) and wrap the connection with electrical tape. Connect the neutral wire to the neutral junction box wire (Usually white or ribbed) with a plastic wire nut (I) and wrap the connection with electrical tape.
8. Move the canopy (E1) up to the ceiling, then fasten the bolt (E2).
9. Fasten lightbulbs (K) to the lampholders.
10. Hang the glass drops (J) from bottom layer to top layer and keep flat surface of glass drop inside. To ensure safety of chandelier during glass drop installation, please maintain level of chandelier by ensuring you install glass drops in balanced way on opposite ends of light.
11. Restore power to the junction box and test ceiling light fixture.

CARE INSTRUCTIONS:

1. Make sure that the power is turned off and bulb has cooled before handling.
2. Wipe clean with a dry cloth / mild soapy solution. Do not use corrosive cleaners.
3. The cable/cord of this ceiling light cannot be replaced: If the cable is damaged, do not use the light.

ENVIRONMENT:

Special waste handling may be required. Please contact your local authorities for more information.