

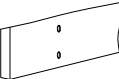







# RESTORATION HARDWARE

## 1920S ESSEX CRYSTAL ROD CHANDELIER LARGE

### PARTS ENCLOSED

ITEMS	DIAGRAM	DESCRIPTION	QTY.
(A)		Wooden Beam (Not included)	—
(B)		Wooden Ceiling Mounting Hardware	1
(C)		Mounting Bolts & nuts(Not included)	1 Set
(D1)		Canopy	1
(D2)			
(E1)		Collar	1
(E2)			
(E3)			
(E4)			
(F)		Quick link	1
(G)			
(H)			
(I)		Bulb+Spares	8+3
(J)			
(K)		Body	1
(L)			

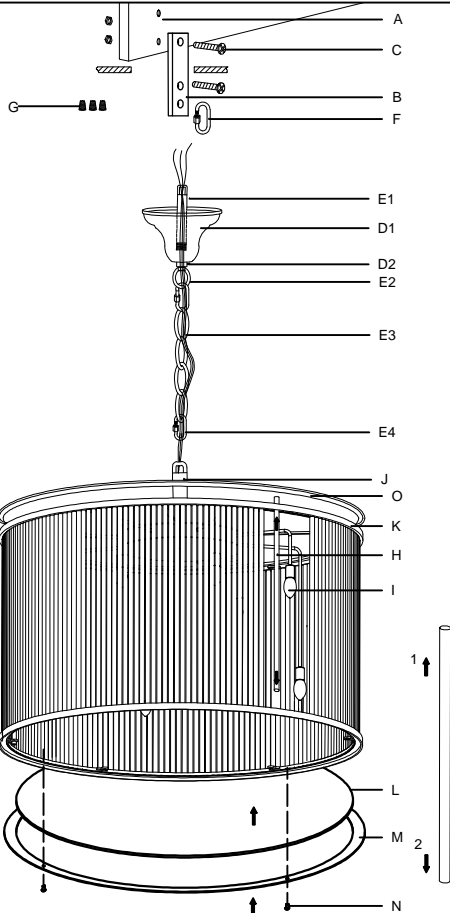

### IMPORTANT SAFETY INSTRUCTIONS:

1. Use an authorized and certified electrician for consultation and installation. Electrician must be familiar with commercial-type applications of very heavy chandeliers.
2. This fixture has been rated for 8 x 25-watt maximum E12 standard bulb.
3. To avoid the risk of fire, do not exceed the recommended wattage.
4. The ceiling must have at least the capacity of 5 times the weight of the ceiling light. For this light at least a ceiling capacity of 390kg is required.
5. The manufacturer and distributor accepts no liability for incorrect installation.
6. For indoor use only.
7. Keep away from children.

### Warnings:

1. Turn-off electricity supply at main circuit panel before installing. Do not connect electricity supply until your ceiling light is fully assembled and installed.
2. All wires are connected. Do not remove the ceiling light from its packaging by pulling on the power cord, as a bad connection may result.
3. To reduce the risk of fire, electrical shock, or personal injury, always turn off the ceiling light and allow it to cool prior to replacing light bulb. Do not touch bulb when fixture is turned on or look directly at light bulb. Keep flammable materials away from light bulb.
4. Deviation from instructions may result in a risk of fire or electric shock.

### PRODUCT DESCRIPTION:

General material: Glass & Iron  
 Height: 60.0 cm  
 Diameter: 90.0 cm  
 Weight: 78.0 kg  
 Grounded / Hardwired

### TO ASSEMBLE:

1. Carefully remove all parts from the box and remove all plastic covering.
2. Turn OFF power to the junction box where the ceiling light will be installed.
3. Loosen bolts (N), then detach metal ring (M) from body (J).
4. Put glass covering (K) on the bottom of body (J), clear side of glass should be facing down, then fasten bolts (N) to body (J).
5. Loosen the bolt of hang straight (E2) and remove the collar (E1) from the hang straight (E2) by unscrewing it. Then insert collar (E1) into canopy (D1) and re-attach collar (E1) to hang straight (E2). Tighten the bolt of the hang straight (E2).
6. Fasten collar (J) to chandelier body (K).
7. Unlock the quick link (E4) at the opposite end of the chain (E3) to attach the chandelier body (K).
8. Attach the wooden ceiling mounting hardware (B) to the wooden beam (A) with mounting bolts and nuts(C).
9. Attach end of the collar (E1) to the wooden ceiling mounting hardware (B) with quick link (F).
10. Connect the ground wire from the fixture to the ground junction box wire (Usually the green or bare wire) with a wire nut (G) and wrap the connection with electrical tape. Connect the hot wire to the hot junction box wire (Usually black or smooth) with a plastic wire nut (G) and wrap the connection with electrical tape. Connect the neutral wire to the neutral junction box wire (Usually white or ribbed) with a plastic wire nut (G) and wrap the connection with electrical tape.
11. Move the canopy (D1) up to the ceiling, then fasten the bolt (D2).
12. Fasten lightbulbs (I) to the lampholders .
13. Detach metal ring (O), then insert glass rod (H) from the mid-section of the ceiling light, first by moving the rod upward through the metal ring on top (as in arrow 1), then move downward toward the base of the table lamp (as in arrow 2).
14. Place metal ring (O) onto body (K) .
15. Restore power to the junction box and test the ceiling fixture.

### CARE INSTRUCTIONS:

1. Make sure that the power is turned off and bulb has cooled before handling.
2. Wipe clean with a dry cloth / mild soapy solution. Do not use corrosive cleaners.
3. The cable/cord of this ceiling light cannot be replaced: If the cable is damaged, do not use the light.

### ENVIRONMENT:

Special waste handling may be required. Please contact your local authorities for more information.