

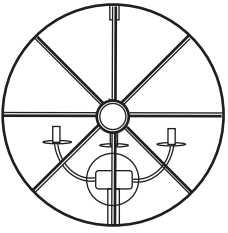



RESTORATION HARDWARE

FOUCAULT'S IRON ORB SCONCE

PARTS ENCLOSED

ITEMS	DIAGRAM	DESCRIPTION	QTY.
(A)		Body	1
(B)		Mounting Screws (Not included)	1 Set
(C)		Wire Nut	3
(D)		Candle Sleeve	3
(E)		Bulb+ Spare	3+1

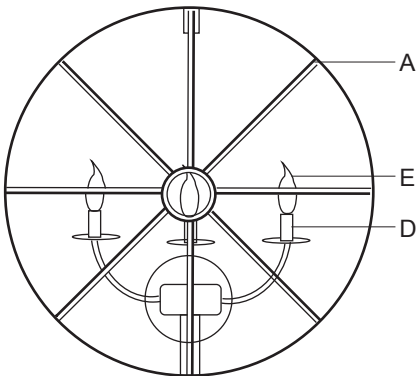
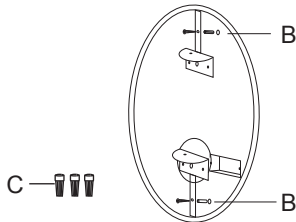

IMPORTANT SAFETY INSTRUCTIONS:

1. Use an authorized and certified electrician for consultation and installation.
2. This fixture has been rated for 3 x 25-watt maximum E12 standard bulb.
3. To avoid the risk of fire, do not exceed the recommended wattage.
4. The wall must have at least the capacity of 5 times the weight of the wall lamp.
For this light at least a wall capacity of 10kg is required.
5. The manufacturer and distributor accepts no liability for incorrect installation.
6. For indoor use only.
7. Keep away from children.

Warnings:

1. Turn-off electricity supply at main circuit panel before installing. Do not connect electricity supply until your wall lamp is fully assembled and installed.
2. All wires are connected. Do not remove the wall lamp from its packaging by pulling on the power cord, as a bad connection may result.
3. To reduce the risk of fire, electrical shock, or personal injury, always turn off the wall lamp and allow it to cool prior to replacing light bulb. Do not touch bulb when fixture is turned on or look directly at light bulb. Keep flammable materials away from light bulb.
4. Deviation from instructions may result in a risk of fire or electric shock.

PRODUCT DESCRIPTION:

General material: Iron
Height: 43.0 cm
Width: 22.0 cm
Length: 43.0 cm
Weight: 2.0 kg
Grounded / Hardwired

TO ASSEMBLE:

1. Carefully remove all parts from the box and remove all plastic covering.
2. Turn OFF power to the junction box where the wall lamp will be installed.
3. Connect the ground wire from the fixture to the ground junction box wire (A) (Usually the green or bare wire) and wrap the connection with electrical tape. Connect the hot wire to the hot junction box wire (A) (Usually black or smooth) with a plastic wire nut (C) and wrap the connection with electrical tape. Connect the neutral wire to the neutral junction box wire (A) (Usually white or ribbed) with a plastic wire nut (C) and wrap the connection with electrical tape.
4. Fix the body (A) on the junction box on the wall, and use the mounting screw (B) to secure the body as the figure on the left.
5. Cover lampholders with candle sleeves (D).
6. Fasten lightbulbs (E) to the lampholders.
7. Restore power to the junction box and test wall lamp fixture.

CARE INSTRUCTIONS:

1. Make sure that the power is turned off and bulb has cooled before handling.
2. Wipe clean with a dry cloth / mild soapy solution. Do not use corrosive cleaners.
3. The cable/cord of this wall lamp cannot be replaced: If the cable is damaged, do not use the lamp.

ENVIRONMENT:

Special waste handling may be required. Please contact your local authorities for more information.