

RESTORATION HARDWARE

Deluxe Vintage Potting Bench

Assembly Instructions & Product Care

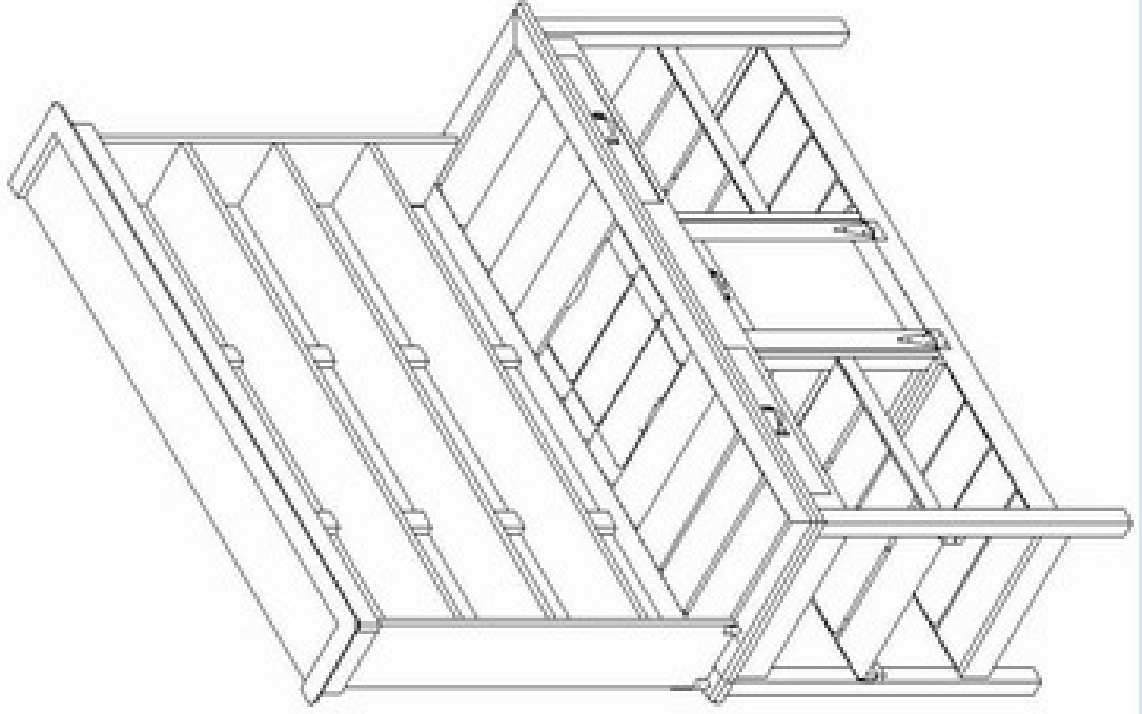

Parts & Hardware Included

Before Assembly, make sure you have all parts and hardware listed below. Unpack your new Vintage Potting Bench on a protected, level surface and identify the following components:

HARDWARE	PARTS
a: SMALL L BRACKETS 20x20	A: TOP VALANCE
b: SCREWS 3.5X30	B: VALANCE ATTACHMENTS 2PCS
c: SCREWS 3X18	C: FRONT VALANCE TRIM
d: MENDING PLATES	D: SHELVES 3PCS
e: LARGE L BRACKETS 40x27	E: SHELF SIDE 2PCS
f: BOLTS	F: CENTER BACK SUPPORT 2PCS
g: CAM LOCKS	G: DRAWER FRONT
h: DOWELS	H: DRAWER SIDES 2PCS
i: HANDLES	I: DRAWER BACK
j: HINGES	J: DRAWER BOTTOM
k: WRENCH	K: TUB COVER
	L: TABLE UNIT
	M: SIDE LEGS 2PCS
	N: SHELF DIVIDER 2 PCS
	O: BOTTOM SHELF OF TABLE
	P: MIDDLE SHELVES 2PCS
	Q: TUB

*There may be additional pieces after assembly due to spare parts.

<p>Step 1: Shelf Unit Assembly</p>	<p>Assemble VALANCE TRIM (part C) to VALANCE ATTACHMENTS (parts B) with hardware g. Attach SHELF SIDES (parts E) to SHELVES (parts D) with Hardware g and h; attach CENTER BACK SUPPORT (part F) to SHELVES (parts D) with Hardware b.</p> <p>Attach assembled VALANCE TRIM (part B and C) to SHELF SIDES (parts E) with Hardware b. Attach TOP VALANCE (part A) to assembled shelves and VALANCE ATTACHMENTS (parts B) with hardware g and h, secure with hardware a and c.</p>
<p>Step 2: Drawer Assembly</p>	<p>Fasten DRAWER SIDES (parts H) to DRAWER BACK (Part I) with Hardware b; Insert DRAWER BOTTOM (part J) into assembled parts (parts H, I); attach DRAWER FRONT (part G) to DRAWER SIDES (parts H) with Hardware g and h; install Drawer Handle (Hardware i) to DRAWER FRONT (part G) using Hardware c. Install top half of Hinge (Hardware j) using hardware c.</p>
<p>Step 3: Leg panels Assembly</p>	<p>Attach SHELF DIVIDER (parts N) onto BOTTOM SHELF OF TABLE (part O) with Hardware b; Attach SHELF DIVIDERS (parts N) to TABLE UNIT (part L) using Hardware b. Attach RIGHT and LEFT SIDE LEGS (parts M) to TABLE UNIT (part L) with Hardware h and f; and BOTTOM SHELF OF TABLE (part O) with Hardware f.</p>
<p>Step 4: Table Unit Assembly</p>	<p>Insert MIDDLE SHELVES (parts P) into assembled unit resting on SIDE LEGS (parts M). Insert assembled box from Step 2 into assembled table unit.</p>
<p>Step 5: Connect Shelf & Table</p>	<p>Insert dowels (hardware h) into assembled shelving unit; put shelf unit on the back of table, connect assembled shelf unit and assembled table unit aligning dowels. Secure with mending plates (hardware d and c). Attach assembled box with hinge using hardware c. Install Desk Drawer Handles (Hardware i) to drawer fronts using Hardware c.</p> <p>Install TUB (part Q) into top of TABLE UNIT (part L), place tub cover part K on top.</p> <p>*Option to secure with L bracket if not situated against a secure surface.</p>

Illustrated Steps

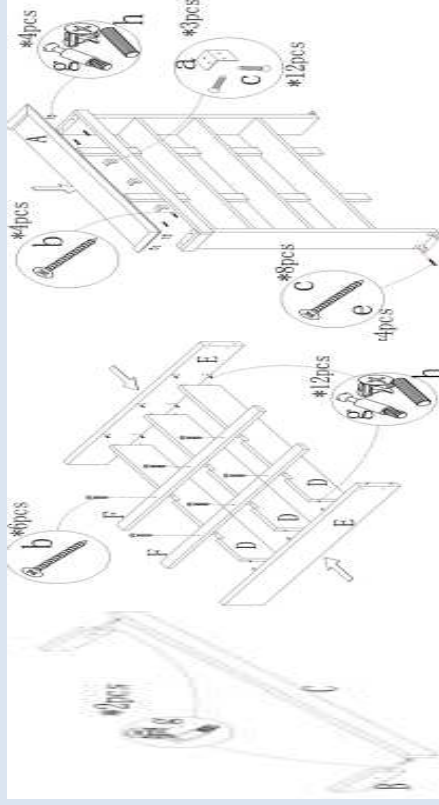

Step 1

Attach part B to Part C with Hardware g (2 pcs);
 Attach parts D to E with Hardware g (12 pcs) and h (12 pcs);
 Attach parts D to parts F with Hardware b (6 pcs);
 Attach assembled parts B and C with Hardware b (4 pcs) to shelving unit;
 Attach part A to part B with hardware g (4 pcs) and h (4pcs). Secure with hardware a (3pcs) and c (12pcs).
 ** (Optional, attach hardware e with c to part E and once base assembled attach for more stability if unit is not leaning against a wall).

Step 2

Fasten parts H to part I with Hardware b (6pcs);
 Insert part J into assembled parts H,I;
 Attach part G to parts H with Hardware g (4pcs) and h (4pcs);
 Install Hardware i (1pc) to part G using hardware c (4pcs)
 Install Hardware j (2pcs) to part G using Hardware c (6pcs).

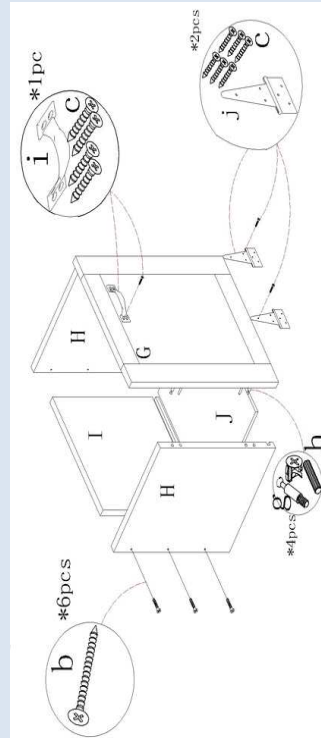

Step 3

Attach parts N to part O with Hardware b (6pcs) *ensure oriented correctly;
 Attach parts N to part L with Hardware b (6pcs);
 Attach part L to art M with Hardware h and f; attach O to parts M with Hardware f (4pcs);

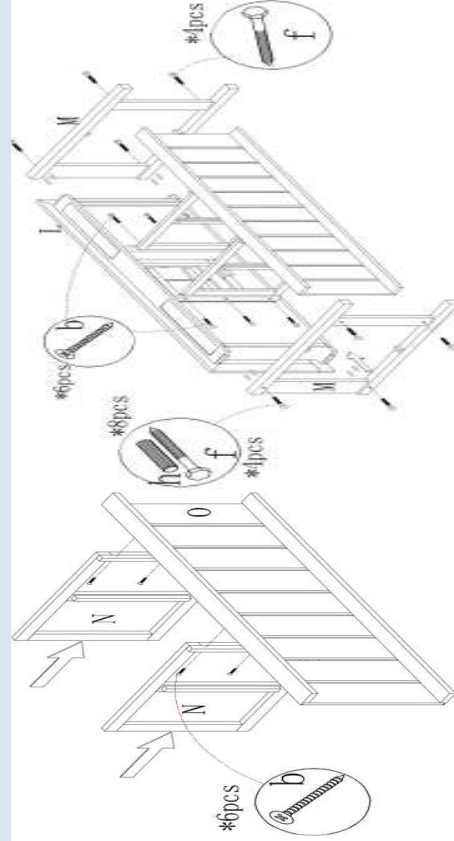

Step 4

Insert the assembled box from Step 2 into assembled base;
Insert parts P onto assembled base.

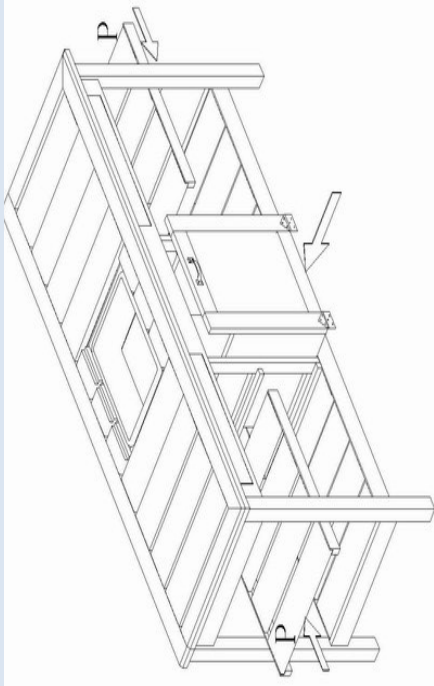

Step 5



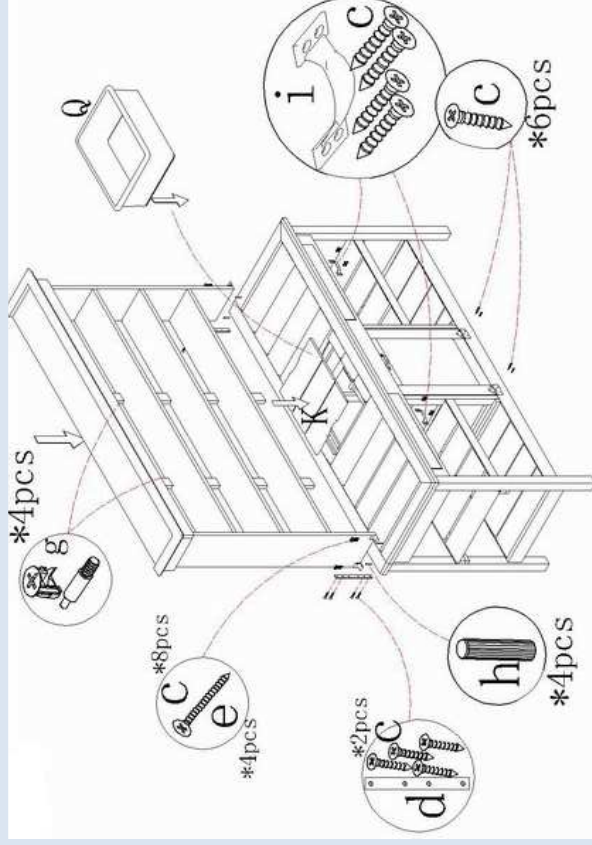









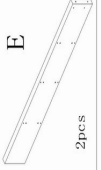
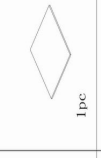

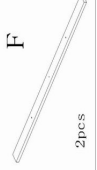
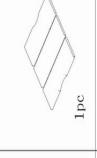



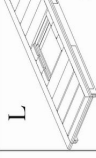



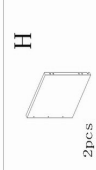
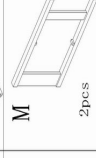

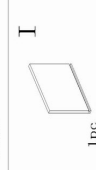
Insert Hardware h (4pcs) into assembled base and place shelf unit onto the back of table;
Secure on both sides with mending plates d (2pcs) with Hardware c (12pcs) and secure shelving unit with hardware g(4pcs).
Attach Hardware i with hardware c onto the front of the drawers;
Secure hinges on part G with Hardware c (6pcs);
Insert tub Q and install part K.
*Optional, if attached L brackets (hardware e in step 1, attach with Hardware c (8pcs) and e (4pcs)).

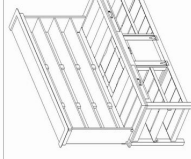

Hardware and Parts

Assembly Instructions

1/3

a		3pcs				
b		28pcs				
c		60pcs				
d		2pcs				
e		4pcs				
f		8pcs				
g		26pcs				
h		32pcs				
i		3pcs				
j		2pcs				
k		1pc				

Your new potting bench is made of a sturdy, high quality hardwood. Its beauty comes from the textured, vintage finish of the bench and the naturally occurring burs, butts and curls combined with the finish and stain colour give this piece its delightful rustic finish. As a result of this finish, no maintenance is required. Excessive dirt and debris can be swept off or washed with a cloth and warm water. No abrasive cleaners or chemicals should be used.

Caring for your Potting Bench