

PARTS ENCLOSED

- (A) Arm (A) (16)
- (B) Arm (B) (8)
- (C) Arm (C) (8)
- (D) Arm (D) (8)
- (E) Arm (E) (8)
- (F) Bolt (30)

PRODUCT DESCRIPTION:

General material: Glass & Iron

Height: 293.0cm (115.35in)

Diameter: 256.0cm (100.78in)

Weight: 167.7kg (369.71lbs)

ARM (T2)

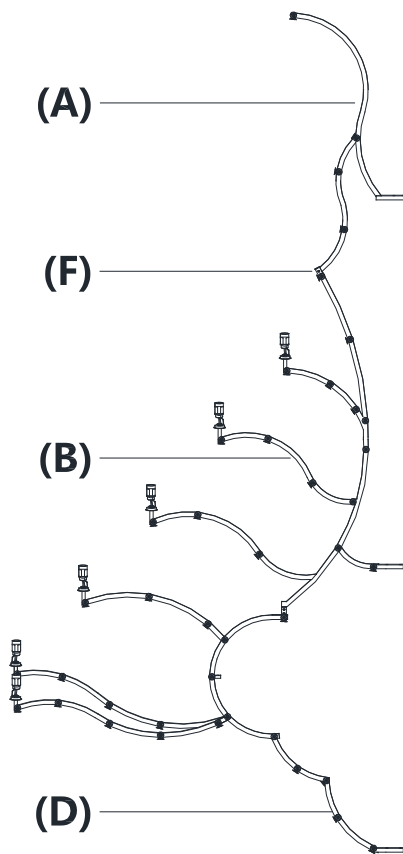

ARM (T1)

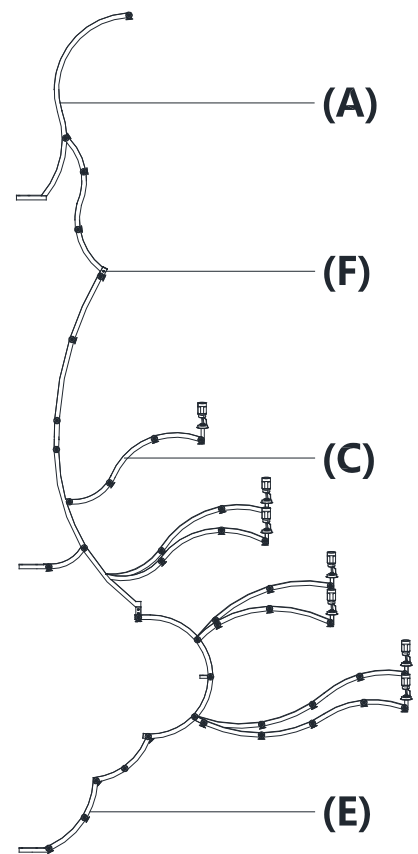

IMPORTANT PLEASE READ**WE RECOMMEND INSTALLATION BY A LICENSED ELECTRICIAN.****SAFETY INSTRUCTIONS:**

1. Use an authorized and certified electrician for consultation and installation. Electrician must be familiar with commercial-type applications of very heavy chandeliers.
2. Use an authorized and certified electrician for consultation and installation.
3. This fixture has been rated for 104 x 25-watt maximum E12 standard bulb.
4. To avoid the risk of fire, do not exceed the recommended wattage.
5. The ceiling must have at least the capacity of 5 times the weight of the ceiling light. For this light, at least a ceiling capacity of 838.5kg (1848.53lbs) is required.
6. The manufacturer and distributor accept no liability for incorrect installation.
7. For indoor use only.
8. Keep away from children.

WARNINGS:

1. Turn off electricity supply at main circuit panel before installing. Do not connect electricity supply until your ceiling light is fully assembled and installed.
2. All wires are connected. Do not remove the ceiling light from its packaging by pulling on the power cord, as a bad connection may result.
3. To reduce the risk of fire, electricity shock, or personal injury when replacing light bulb, do not touch bulb when fixture is turned on. Always turn off the ceiling light and allow it to cool prior to changing bulb. Never look directly at a lite bulb. Keep flammable materials away from lite bulb.
4. Deviation from instructions may result in a risk of fire or electric shock.

 **WARNING:** This product can expose you to lead, which is known to the State of California to cause cancer and birth defects or other reproductive harm. For more information, go to www.P65Warnings.ca.gov.

THIS IS NOT A TOY AND THE PRODUCT HAS NO PLAY VALUE .

 **WARNING: STRANGULATION HAZARD**

Keep cord at least 3 ft away from cribs, bassinets, and toddler beds. Keep out of reach of children under 3.

ASSEMBLY & INSTALLATION:

1. Carefully remove all parts from the box and remove all plastic covering.
2. Attach the arm (A),(B),(D) to the arm (T2) with a fixed bolts (F).
3. Attach the arm (A),(C),(E) to the arm (T1) with a fixed bolts (F).

(To be continued.)

CARE INSTRUCTIONS:

1. Make sure that the power is turned off, and bulb has cooled before handling.
2. Wipe clean with a dry cloth/mild soapy solution. Do not use corrosive cleaners.
3. The cable/cord of this ceiling light cannot be replaced; if the cable is damaged, do not use the light.

ENVIRONMENT:

Special waste handling may be required. Please contact your local authorities for more information.

PARTS ENCLOSED

- (N) Mail Wire (5)
- (O) Wire Nut (32)
- (G) Heat Shrinkable Sleeve (32)
- (H) Pliers (not included) (1)
- (I) Bolt+Spare (55)
- (I1) Bolt+Spare (100)
- (J) Pliers (not included) (16)
- (K) Collar (1)
- (L) Body (1)
- (L1) Round Housing (2)
- (L2) Glass Bowl (2)
- (L3) Bolt (2)
- (L4) Meson (2)
- (L5) Round Housing (1)
- (L6) Glass Bowl (1)
- (L7) Nut (1)
- (L8) Round Lid (1)
- (L9) Metal Part (1)
- (L10) Bolt (1)

PRODUCT DESCRIPTION:

General material: Glass & Iron
 Height: 293.0cm (115.35in)
 Diameter: 256.0cm (100.78in)
 Weight: 167.7kg (369.71lbs)

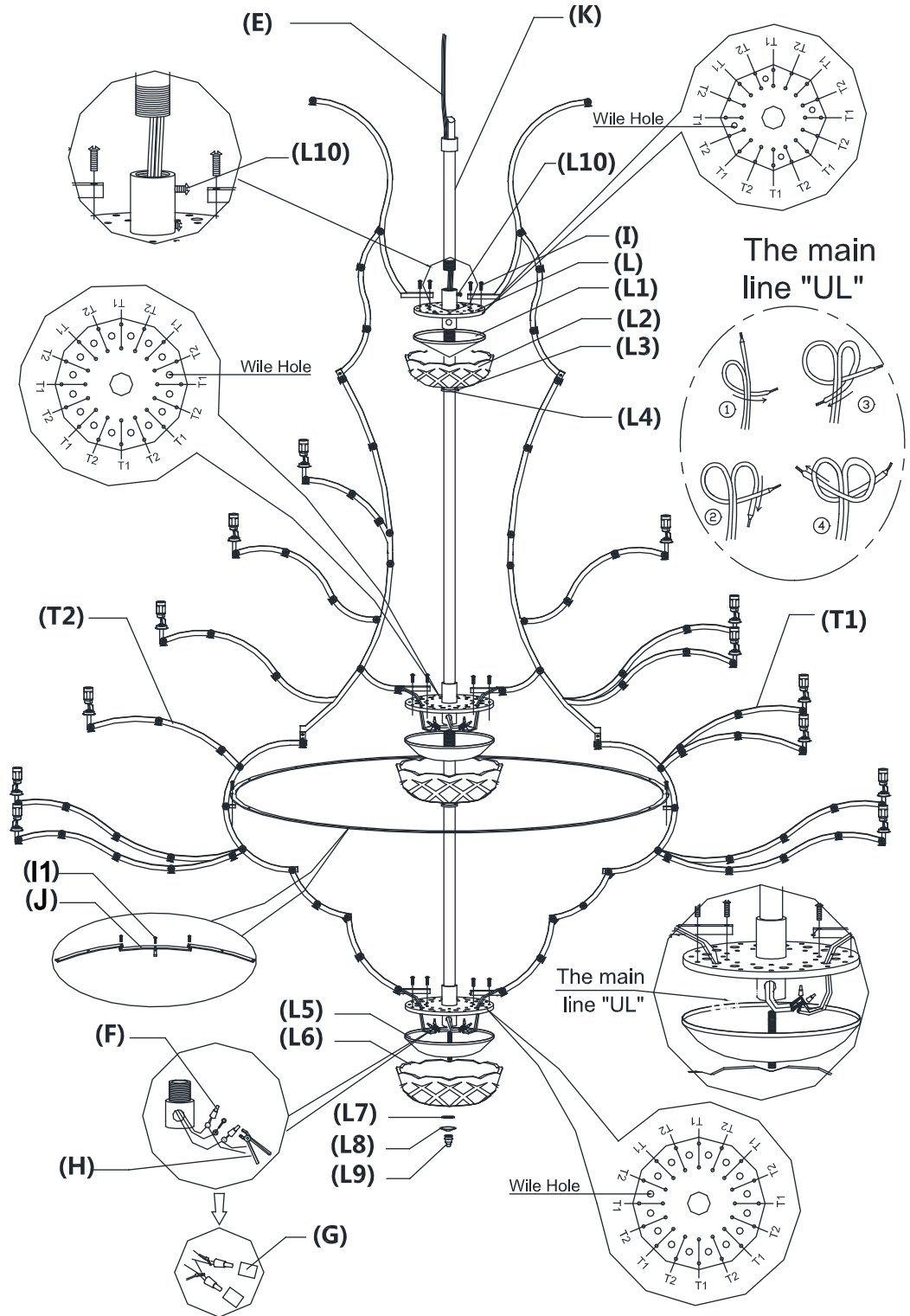

IMPORTANT PLEASE READ**WE RECOMMEND INSTALLATION BY A LICENSED ELECTRICIAN.****SAFETY INSTRUCTIONS:**

1. Use an authorized and certified electrician for consultation and installation. Electrician must be familiar with commercial-type applications of very heavy chandeliers.
2. Use an authorized and certified electrician for consultation and installation.
3. This fixture has been rated for 104 x 25-watt maximum E12 standard bulb.
4. To avoid the risk of fire, do not exceed the recommended wattage.
5. The ceiling must have at least the capacity of 5 times the weight of the ceiling light. For this light, at least a ceiling capacity of 838.5kg (1848.53lbs) is required.
6. The manufacturer and distributor accept no liability for incorrect installation.
7. For indoor use only.
8. Keep away from children.

WARNINGS:

1. Turn off electricity supply at main circuit panel before installing. Do not connect electricity supply until your ceiling light is fully assembled and installed.
2. All wires are connected. Do not remove the ceiling light from its packaging by pulling on the power cord, as a bad connection may result.
3. To reduce the risk of fire, electricity shock, or personal injury when replacing light bulb, do not touch bulb when fixture is turned on. Always turn off the ceiling light and allow it to cool prior to changing bulb. Never look directly at a lite bulb. Keep flammable materials away from lite bulb.
4. Deviation from instructions may result in a risk of fire or electric shock.

 **WARNING:** This product can expose you to lead, which is known to the State of California to cause cancer and birth defects or other reproductive harm. For more information, go to www.P65Warnings.ca.gov.

THIS IS NOT A TOY AND THE PRODUCT HAS NO PLAY VALUE.

 **WARNING: STRANGULATION HAZARD**

Keep cord at least 3 ft away from cribs, bassinets, and toddler beds.
Keep out of reach of children under 3.

ASSEMBLY & INSTALLATION:

4. Turn OFF power to the junction box where the ceiling light will be installed.
5. Loosen bolts (L3) and meson (L4), and detach glass bowl (L2) and round housing (L1) from the body (L).
6. Loosen metal part (L9) and detach round lid (L8) from body (L), then loosen the nut (L7) and detach glass bowl (L6) and round housing (L5) from the body (L).
7. Insert the branch wire of arm (T1) and (T2) to body (L) through the wire holes on the metal plate. Please note the rank of the two arms is arm (T1)-arm (T2)-arm (T1)-arm (T2)-arm (T1)-arm (T2)-arm (T1)-arm (T2).
8. Fix arm (T1) and (T2) to body (L) with bolts (I1).
9. Connect the branch live/neutral to live cord of mail wire (N) to the main line "UL" wire nut (O) by pliers (H). Wrap the connection with heat shrinkable sleeve (G). Insert mail wire (N) through to body (L).
10. Connect the branch live/neutral to live cord of mail wire (N) to the main line "UL" wire nut (O) by pliers (H). Wrap the connection with heat shrinkable sleeve (G). Insert mail wire (N) through to body (L).
11. Re-attach round housing (L1), glass bowl (L2), and meson (L4) to body (L) and fasten bolts (L3) to body (L).
12. Re-attach round housing (L5), glass bowl (L6), round lid (L7), and nut (L8) to body (L). Fasten metal part (L9) to body (L).
13. **Loosen the bolts (L10). Then fasten collar (K) to chandelier body (L). Tighten the bolts (L10) on body (L).**

(To be continued.)

CARE INSTRUCTIONS:

1. Make sure that the power is turned off, and bulb has cooled before handling.
2. Wipe clean with a dry cloth/mild soapy solution. Do not use corrosive cleaners.
3. The cable/cord of this ceiling light cannot be replaced; if the cable is damaged, do not use the light.

ENVIRONMENT:

Special waste handling may be required. Please contact your local authorities for more information.

PARTS ENCLOSED

- (M) Wooden Beam (Not included)
- (P1) Wooden Ceiling Mounting Hardware (1)
- (P2) Quick Link (1)
- (Q) Mounting Bolts & Nuts (Not included) (1 Set)
- (R1) Canopy (1)
- (R2) Bolt (1)
- (S1) Collar (1)
- (S2) Hang Straight (1)
- (S3) Chain (1)
- (S4) Quick Link (1)
- (S5) Bolt (1)
- (U) Wire Nut (10)
- (V) Bulb+Spare (104+35)
- (W) Candle Sleeve (104)
- (Y) Glass Dishes (104)

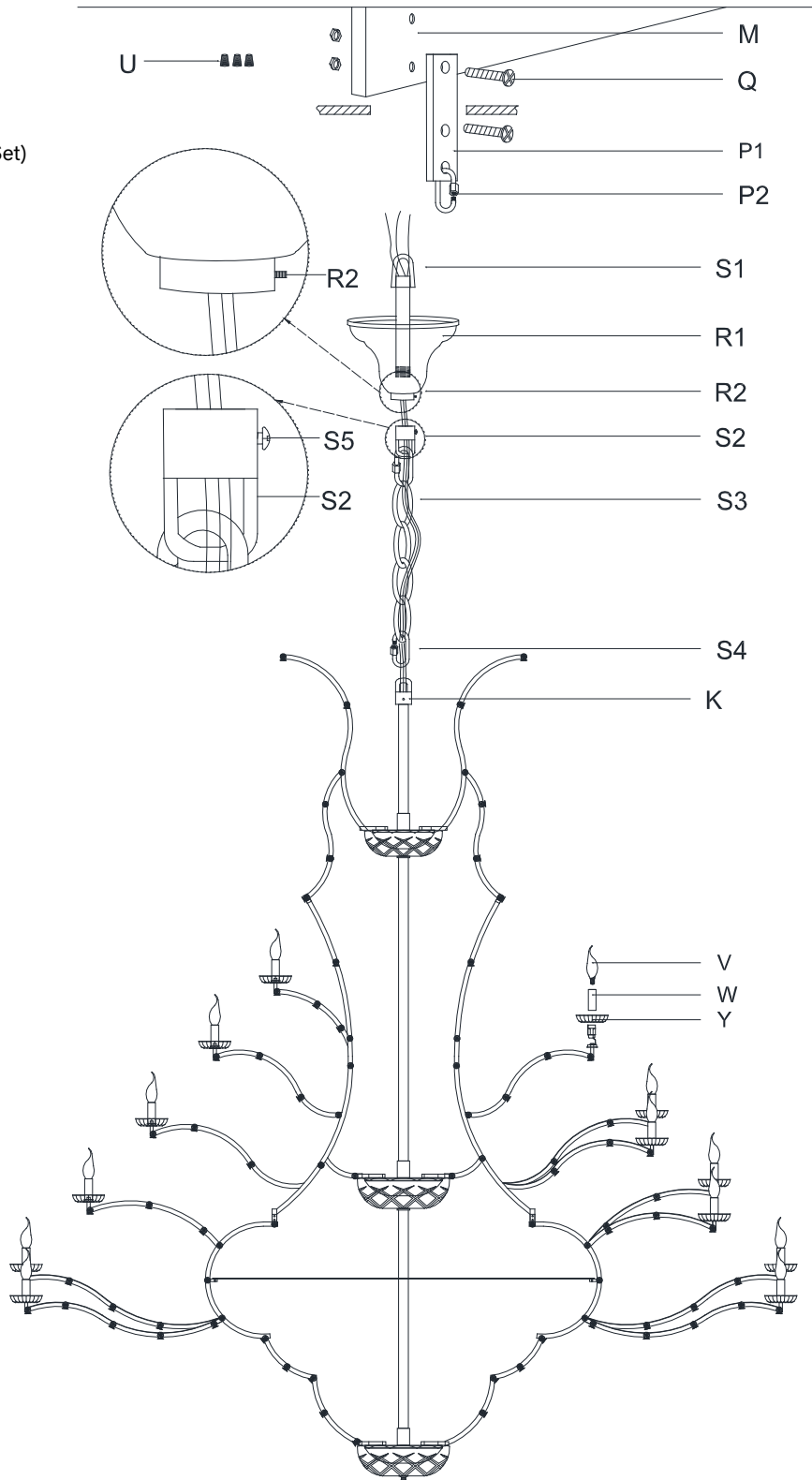

PRODUCT DESCRIPTION:

- General material: Glass & Iron
- Height: 293.0cm (115.35in)
- Diameter: 256.0cm (100.78in)
- Weight: 167.7kg (369.71lbs)

IMPORTANT PLEASE READ**WE RECOMMEND INSTALLATION BY A LICENSED ELECTRICIAN.****SAFETY INSTRUCTIONS:**

1. Use an authorized and certified electrician for consultation and installation. Electrician must be familiar with commercial-type applications of very heavy chandeliers.
2. Use an authorized and certified electrician for consultation and installation.
3. This fixture has been rated for 104 x 25-watt maximum E12 standard bulb.
4. To avoid the risk of fire, do not exceed the recommended wattage.
5. The ceiling must have at least the capacity of 5 times the weight of the ceiling light. For this light, at least a ceiling capacity of 838.5kg (1848.53lbs) is required.
6. The manufacturer and distributor accept no liability for incorrect installation.
7. For indoor use only.
8. Keep away from children.

WARNINGS:

1. Turn off electricity supply at main circuit panel before installing. Do not connect electricity supply until your ceiling light is fully assembled and installed.
2. All wires are connected. Do not remove the ceiling light from its packaging by pulling on the power cord, as a bad connection may result.
3. To reduce the risk of fire, electricity shock, or personal injury when replacing light bulb, do not touch bulb when fixture is turned on. Always turn off the ceiling light and allow it to cool prior to changing bulb. Never look directly at a lite bulb. Keep flammable materials away from lite bulb.
4. Deviation from instructions may result in a risk of fire or electric shock.

 **WARNING:** This product can expose you to lead, which is known to the State of California to cause cancer and birth defects or other reproductive harm. For more information, go to www.P65Warnings.ca.gov.

THIS IS NOT A TOY AND THE PRODUCT HAS NO PLAY VALUE.

 **WARNING: STRANGULATION HAZARD**

Keep cord at least 3 ft away from cribs, bassinets, and toddler beds.
Keep out of reach of children under 3.

ASSEMBLY & INSTALLATION:

14. Loosen the bolt (S5) of hang straight (E2) and remove the collar (S1) from the hang straight (S2) by unscrewing it. Then insert collar(S1) into canopy (R) and re-attach collar (S1) to hang straight (S2). Tighten the bolt (S5) of the hang straight (S2).
15. Unlock the quick link (S4) at the opposite end of the chain (S3) to attach the chandelier body (K).
16. Attach the wooden ceiling mounting hardware (P1) to the wooden beam (M) with mounting bolts and nuts (Q).
17. Unlock quick link (P2) to attach the end of the collar (S1).
18. Connect the ground wire from the fixture to the ground junction box wire (usually the green or bare wire) with a wire nut (U) and wrap the connection with electrical tape. Connect the hot wire to the hot junction box wire (usually black or smooth) with a plastic wire nut (U) and wrap the connection with electrical tape. Connect the neutral wire to the neutral junction box wire (usually white or ribbed) with a plastic wire nut (U) and wrap the connection with electrical tape.
19. Move the canopy (R1) up to the ceiling, then fasten the bolt (R2).
20. Position glass dishes (Y) and candle sleeves (W), and hang the crystals as per drawing on left.
21. Insert lightbulbs (V) to the lampholders.
22. Restore power to the junction box and test ceiling light fixture.

CARE INSTRUCTIONS:

1. Make sure that the power is turned off, and bulb has cooled before handling.
2. Wipe clean with a dry cloth/mild soapy solution. Do not use corrosive cleaners.
3. The cable/cord of this ceiling light cannot be replaced; if the cable is damaged, do not use the light.

























ENVIRONMENT:

Special waste handling may be required. Please contact your local authorities for more information.

RH

ROCOCO ROUND 101IN CHANDELIER-D

CRYSTALS AS PER DRAWING:

<p>1 14mmX31pcs</p>  <p>89X62mm 16PCS</p>	<p>2 14mmX7pcs</p>  <p>89X62mm 16PCS</p>	<p>3 14mmX2pcs</p>  <p>89X62mm 16PCS</p>	<p>4 14mmX1pcs</p>  <p>89X62mm 104PCS</p>	<p>5 14mmX1pcs</p>  <p>50X38mm 416PCS</p>	<p>6 14mmX6pcs</p>  <p>89X62mm 32PCS</p>	<p>7 14mmX7pcs</p>  <p>89X62mm 32PCS</p>	<p>8 14mmX9pcs</p>  <p>89X62mm 32PCS</p>	<p>9 14mmX15pcs</p>  <p>89X62mm 16PCS</p>	<p>10 14mmX18pcs</p>  <p>89X62mm 16PCS</p>	<p>11 14mmX16pcs</p>  <p>89X62mm 16PCS</p>	<p>12 14mmX10pcs</p>  <p>89X62mm 8PCS</p>	<p>13 14mmX8pcs</p>  <p>D50mm 1PCS</p>
<p>14 14mmX17pcs</p>  <p>89X62mm 8PCS</p>	<p>15 14mmX13pcs</p>  <p>89X62mm 16PCS</p>	<p>16 14mmX13pcs</p>  <p>89X62mm 24PCS</p>	<p>17 14mmX15pcs</p>  <p>89X62mm 24PCS</p>	<p>18 14mmX13pcs</p>  <p>89X62mm 32PCS</p>	<p>19 14mmX19pcs</p>  <p>89X62mm 16PCS</p>	<p>20 14mmX19pcs</p>  <p>89X62mm 16PCS</p>	<p>21 14mmX25pcs</p>  <p>89X62mm 16PCS</p>	<p>22 14mmX21pcs</p>  <p>89X62mm 16PCS</p>	<p>23 14mmX21pcs</p>  <p>89X62mm 16PCS</p>	<p>24 14mmX35pcs</p>  <p>89X62mm 16PCS</p>	<p>25 14mmX7pcs</p>  <p>89X62mm 16PCS</p>	

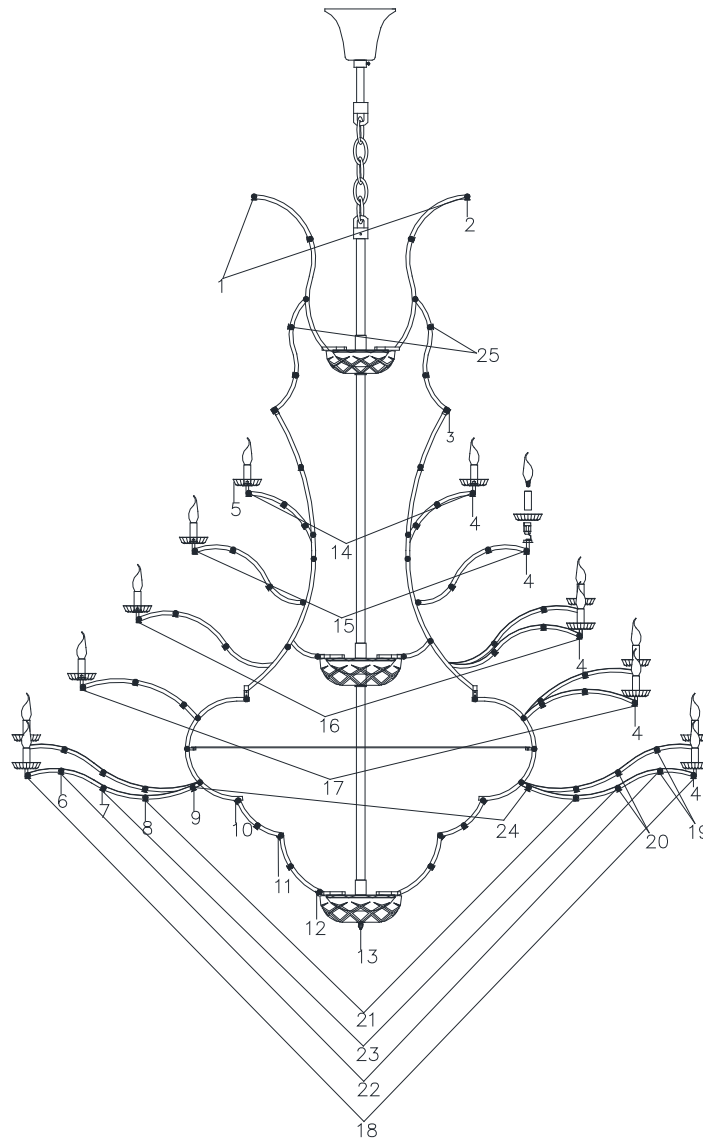

CEILING SAFETY CABLE ASSEMBLY

1. Remove the Nut locker A & B by loosening the Screw from the Ceiling safety cable before installation.
2. Insert the Ceiling safety cable through the Nut lockers as the drawing shows.
3. Fasten the Nut locker A with Screw by screwdriver.
4. Fasten the Nut locker B with Screw by screwdriver.

