







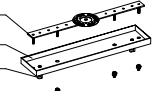

# RESTORATION HARDWARE

## 19TH C. ROCOCO IRON & CRYSTAL RECTANGULAR CHANDELIER 73 "

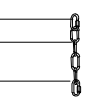
### PARTS ENCLOSED

ITEMS	DIAGRAM	DESCRIPTION	QTY.
(A)		Junction Box (Not included) 22.7kg (50LB). MIN.FIXTURE RATED	1
(B)		Mounting Screws (Not included)	8 Sets
(C1)		Ceiling Plate	1
(C2)		Ceiling Box	1
(C3)		Hang Straight	2
(C4)		Screw Cap	4
(D1)		Quick Link	2
(D2)		Chain	
(D3)		Quick link	
(E)		Wire Nut	6
(F)		Bulb+Spare	36+12
(G)		Candle Sleeve	36
(H)		Body	1
(H1)		Hang Straight	

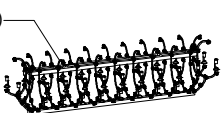
### IMPORTANT SAFETY INSTRUCTIONS:

1. Use an authorized and certified electrician for consultation and installation.
2. This fixture has been rated for 36 x 25-watt maximum E12 standard bulb.
3. To avoid the risk of fire, do not exceed the recommended wattage.
4. The ceiling must have at least the capacity of 5 times the weight of the ceiling light.  
For this light at least a ceiling capacity of 212kg(466.4LB) is required.
5. The manufacturer and distributor accepts no liability for incorrect installation.
6. For indoor use only.
7. Keep away from children.

### Warnings:

1. Turn-off electricity supply at main circuit panel before installing. Do not connect electricity supply until your ceiling light is fully assembled and installed.
2. All wires are connected. Do not remove the ceiling light from its packaging by pulling on the power cord, as a bad connection may result.
3. To reduce the risk of fire, electrical shock, or personal injury, always turn off the ceiling light and allow it to cool prior to replacing light bulb. Do not touch bulb when fixture is turned on or look directly at light bulb. Keep flammable materials away from light bulb.
4. Deviation from instructions may result in a risk of fire or electric shock.

### PRODUCT DESCRIPTION:

General material: Glass & Iron  
 Height: 49.0 cm (19.2in)  
 Width: 41.0 cm (16.1in)  
 Length: 180 cm(71in)  
 Weight 42.4 kg(93.3lbs)  
 Grounded / Hardwired

### TO ASSEMBLE:

1. Carefully remove all parts from the box and remove all plastic covering.
2. Turn OFF power to the junction box where the ceiling light will be installed.
3. Loosen the screw cap (C4) from ceiling box (C2) and remove ceiling plate (C1) from ceiling box (C2).
4. Unlock quick link (D3) to attach the hang straight (H1) on the body (H).
5. Unlock quick link (D1) to attach the hang straight (C3) on the ceiling box (C2).
6. Attach the ceiling plate (C1) to the ceiling with mounting screws (B).
7. Connect the ground wire from the fixture to the ground junction box wire (Usually the green or bare wire) with a wire nut (E) and wrap the connection with electrical tape. Connect the hot wire to the hot junction box wire (Usually black or smooth) with a plastic wire nut (E) and wrap the connection with electrical tape. Connect the neutral wire to the neutral junction box wire (Usually white or ribbed) with a plastic wire nut (E) and wrap the connection with electrical tape.
8. Fix the ceiling box (C2) to the ceiling plate (C1) by fasten the screw cap (C4).
9. Position glass dishes (9) and candle sleeves (G), and hang the crystals as per drawing on left.
10. Fasten lightbulbs (F) to the lampholders.
11. Restore power to the junction box and test ceiling light fixture.







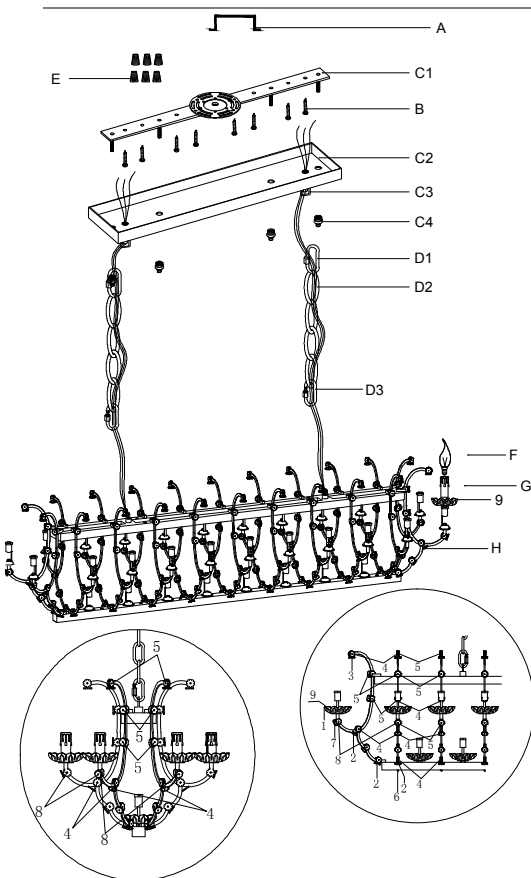

### CARE INSTRUCTIONS:

1. Make sure that the power is turned off and bulb has cooled before handling.
2. Wipe clean with a dry cloth / mild soapy solution. Do not use corrosive cleaners.
3. The cable/cord of this ceiling light cannot be replaced: If the cable is damaged, do not use the light.

### ENVIRONMENT:

Special waste handling may be required. Please contact your local authorities for more information.



								
14mmx1pcs	14mmx20pcs	3	14mmx9pcs	14mmx7pcs	14mmx3pcs	14mmx1pcs	14mmx11pcs	ø85x23mm
50x30mm 104pcs	63x43mm 52pcs	63x43mm 26pcs	63x43mm 70pcs	63x43mm 74pcs	63x43mm Bowl Side 11pcs	63x43mm 26pcs	63x43mm 6pcs	36pcs

## CEILING SAFETY CABLE ASSEMBLY

1. Remove the Nut locker A & B by loosening the Screw from the Ceiling safety cable before installation.
2. Insert the Ceiling safety cable through the Nut lockers as the drawing shows.
3. Fasten the Nut locker A with Screw by screwdriver.
4. Fasten the Nut locker B with Screw by screwdriver.

