

KENSINGTON COLLECTION



All dimensions are given in inches. See the attached "Dimensions Diagram" sheet for more information on the keys used in this chart.

	OVERALL WIDTH A	OVERALL DEPTH B	OVERALL HEIGHT C	FRAME HEIGHT D	SEAT HEIGHT E	ARM HEIGHT F	FOOT HEIGHT G	SEAT HEIGHT (FLOOR TO CUSHION SEAM) H	SEAT HEIGHT (FLOOR TO FRAME) I	INSIDE SEAT WIDTH J	INSIDE SEAT DEPTH W/ BACK CUSHION K	INSIDE SEAT DEPTH W/O BACK CUSHION L	INSIDE BACK HEIGHT W/ SEAT & BACK CUSHIONS M	INSIDE BACK HEIGHT W/ SEAT CUSHION N	# OF BACK CUSHIONS	# OF SEAT CUSHIONS	ACCENT PILLOWS	ARM HEIGHT W/ SEAT CUSHION O	ARM HEIGHT W/O SEAT CUSHION P	ARM WIDTH Q	SLEEPER DEPTH OVERALL R	SLEEPER DEPTH INSIDE S	
7' PETITE SOFA	84	33¾	29½	29½	19¾	29½	4½	18¾	12	65	24½	24½	9¾	9¾	17½	-	2	0	9¾	17½	9½	-	-
7' CLASSIC SOFA	84	38	30¾	30¾	20¾	30¾	4½	19	12¾	58	24½	24½	10½	10½	18½	-	2	0	10½	18½	13	-	-
7' LUXE SOFA	84	44	30¾	30¾	20¾	30¾	4½	19	12¾	58	29½	29½	10½	10½	18½	-	2	0	10½	18½	13	-	-
8' PETITE SOFA	96	33¾	29½	29½	19¾	29½	4½	18¾	12	77	24½	24½	9¾	9¾	17½	-	2	0	9¾	17½	9½	-	-
8' CLASSIC SOFA	96	38	30¾	30¾	20¾	30¾	4½	19	12¾	70	24½	24½	10½	10½	18½	-	2	0	10½	18½	13	-	-
8' LUXE SOFA	96	44	30¾	30¾	20¾	30¾	4½	19	12¾	70	29½	29½	10½	10½	18½	-	2	0	10½	18½	13	-	-
9' PETITE SOFA	108	33¾	29½	29½	19¾	29½	4½	18¾	12	89	24½	24½	9¾	9¾	17½	-	3	0	9¾	17½	9½	-	-
9' CLASSIC SOFA	108	38	30¾	30¾	20¾	30¾	4½	19	12¾	82	24½	24½	10½	10½	18½	-	2	0	10½	18½	13	-	-
9' LUXE SOFA	108	44	30¾	30¾	20¾	30¾	4½	19	12¾	82	29½	29½	10½	10½	18½	-	2	0	10½	18½	13	-	-
10' CLASSIC SOFA	120	38	30¾	30¾	20¾	30¾	4½	19	12¾	94	24½	24½	10½	10½	18½	-	2	0	10½	18½	13	-	-
10' LUXE SOFA	120	44	30¾	30¾	20¾	30¾	4½	19	12¾	94	29½	29½	10½	10½	18½	-	2	0	10½	18½	13	-	-
163" SOFA	163	47	30¾	30¾	20¾	30¾	4½	19	12¾	137	29½	29½	10½	10½	18½	-	4	0	10½	18½	13	-	-
PETITE CHAIR	43	33¾	29½	29½	19¾	29½	4½	18¾	12	24	24½	24½	9¾	9¾	17½	-	1	0	9¾	17½	9½	-	-
CLASSIC CHAIR	49	38	30¾	30¾	20¾	30¾	4½	19	12¾	23	24½	24½	10½	10½	18½	-	1	0	10½	18½	13	-	-

KENSINGTON COLLECTION



All dimensions are given in inches. See the attached "Dimensions Diagram" sheet for more information on the keys used in this chart.

	OVERALL WIDTH A	OVERALL DEPTH B	OVERALL HEIGHT C	FRAME HEIGHT D	SEAT HEIGHT E	ARM HEIGHT F	FOOT HEIGHT G	SEAT HEIGHT (FLOOR TO CUSHION SEAM) H	SEAT HEIGHT (FLOOR TO FRAME) I	INSIDE SEAT WIDTH J	INSIDE SEAT DEPTH W/ BACK CUSHION K	INSIDE SEAT DEPTH W/O BACK CUSHION L	INSIDE BACK HEIGHT W/ SEAT & BACK CUSHIONS M	INSIDE BACK HEIGHT W/ SEAT CUSHION N	# OF BACK CUSHIONS	# OF SEAT CUSHIONS	ACCENT PILLOWS	ARM HEIGHT W/ SEAT CUSHION O	ARM HEIGHT W/O SEAT CUSHION P	ARM WIDTH Q	SLEEPER DEPTH OVERALL R	SLEEPER DEPTH INSIDE S	
LUXE CHAIR	49	44	30¾	30¾	20¾	30¾	4½	19	12¾	23	29½	29½	10½	10½	18½	-	1	0	10½	18½	13	-	-
CLASSIC SWIVEL CHAIR	49	38	30¾	30¾	20¾	30¾	-	19	12¾	23	24½	24½	10½	10½	18½	-	1	0	10½	18½	13	-	-
LUXE SWIVEL CHAIR	49	44	30¾	30¾	20¾	30¾	4½	19	12¾	23	29½	29½	10½	10½	18½	-	1	0	10½	18½	13	-	-
PETITE OTTOMAN	36	25	19	19	19	-	4½	18	12	36	-	-	-	-	-	1	-	-	-	-	-	-	-
OTTOMAN	39	28	20	20	20	-	4½	18	12¾	39	-	-	-	-	-	1	-	-	-	-	-	-	-
COFFEE OTTOMAN	60	36	20	20	20	-	4½	18	12¾	60	-	-	-	-	-	1	-	-	-	-	-	-	-
DAYBED	108	60	30¾	30¾	20¾	30¾	4½	19	12¾	82	45½	45½	10½	10½	18½	-	2	0	10½	18½	13	-	-
5' PETITE ARMLESS SOFA	60	33¾	29½	29½	19¾	-	4½	18¾	12	60	24½	24½	9¾	9¾	17½	-	1	0	-	-	-	-	-
5' CLASSIC ARMLESS SOFA	60	38	30¾	30¾	20¾	-	4½	19	12¾	60	24½	24½	10½	10½	18½	-	1	0	-	-	-	-	-
6' PETITE ARMLESS SOFA	72	33¾	29½	29½	19¾	-	4½	18¾	12	72	24½	24½	9¾	9¾	17½	-	2	0	-	-	-	-	-
6' CLASSIC ARMLESS SOFA	72	38	30¾	30¾	20¾	-	4½	19	12¾	72	24½	24½	10½	10½	18½	-	2	0	-	-	-	-	-
6' LUXE ARMLESS SOFA	72	44	30¾	30¾	20¾	-	4½	19	12¾	72	29½	29½	10½	10½	18½	-	2	0	-	-	-	-	-
7' PETITE ARMLESS SOFA	84	33¾	29½	29½	19¾	-	4½	18¾	12	84	24½	24½	9¾	9¾	17½	-	3	0	-	-	-	-	-
7' CLASSIC ARMLESS SOFA	84	38	30¾	30¾	20¾	-	4½	19	12¾	84	24½	24½	10½	10½	18½	-	3	0	-	-	-	-	-

KENSINGTON COLLECTION



All dimensions are given in inches. See the attached "Dimensions Diagram" sheet for more information on the keys used in this chart.

	OVERALL WIDTH A	OVERALL DEPTH B	OVERALL HEIGHT C	FRAME HEIGHT D	SEAT HEIGHT E	ARM HEIGHT F	FOOT HEIGHT G	SEAT HEIGHT (FLOOR TO CUSHION SEAM) H	SEAT HEIGHT (FLOOR TO FRAME) I	INSIDE SEAT WIDTH J	INSIDE SEAT DEPTH W/ BACK CUSHION K	INSIDE SEAT DEPTH W/O BACK CUSHION L	INSIDE BACK HEIGHT W/ SEAT & BACK CUSHIONS M	INSIDE BACK HEIGHT W/ SEAT CUSHION N	# OF BACK CUSHIONS	# OF SEAT CUSHIONS	ACCENT PILLOWS	ARM HEIGHT W/ SEAT CUSHION O	ARM HEIGHT W/O SEAT CUSHION P	ARM WIDTH Q	SLEEPER DEPTH OVERALL R	SLEEPER DEPTH INSIDE S	
7' LUXE ARMLESS SOFA	84	44	30¾	30¾	20¾	-	4½	19	12¾	84	29½	29½	10½	10½	18½	-	3	0	-	-	-	-	-
8' PETITE ARMLESS SOFA	96	33¾	29½	29½	19¾	-	4½	18¾	12	96	24½	24½	9¾	9¾	17½	-	3	0	-	-	-	-	-
8' CLASSIC ARMLESS SOFA	96	38	30¾	30¾	20¾	-	4½	19	12¾	96	24½	24½	10½	10½	18½	-	3	0	-	-	-	-	-
8' LUXE ARMLESS SOFA	96	44	30¾	30¾	20¾	-	4½	19	12¾	96	29½	29½	10½	10½	18½	-	3	0	-	-	-	-	-
9' PETITE ARMLESS SOFA	108	33¾	29½	29½	19¾	-	4½	18¾	12	108	24½	24½	9¾	9¾	17½	-	3	0	-	-	-	-	-
9' CLASSIC ARMLESS SOFA	108	38	30¾	30¾	20¾	-	4½	19	12¾	108	24½	24½	10½	10½	18½	-	3	0	-	-	-	-	-
9' LUXE ARMLESS SOFA	108	44	30¾	30¾	20¾	-	4½	19	12¾	108	29½	29½	10½	10½	18½	-	3	0	-	-	-	-	-
10' CLASSIC ARMLESS SOFA	120	38	30¾	30¾	20¾	-	4½	19	12¾	120	24½	24½	10½	10½	18½	-	4	0	-	-	-	-	-
10' LUXE ARMLESS SOFA	120	44	30¾	30¾	20¾	-	4½	19	12¾	120	29½	29½	10½	10½	18½	-	4	0	-	-	-	-	-
7' PETITE LEFT-ARM SOFA	84	33¾	29½	29½	19¾	29½	4½	18¾	12	74½	24½	24½	9¾	9¾	17½	-	2	0	9¾	17½	9½	-	-
7' PETITE RIGHT-ARM SOFA	84	33¾	29½	29½	19¾	29½	4½	18¾	12	74½	24½	24½	9¾	9¾	17½	-	2	0	9¾	17½	9½	-	-
7' CLASSIC LEFT-ARM SOFA	84	38	30¾	30¾	20¾	30¾	4½	19	12¾	71	24½	24½	10½	10½	18½	-	2	0	10½	18½	13	-	-
7' CLASSIC RIGHT-ARM SOFA	84	38	30¾	30¾	20¾	30¾	4½	19	12¾	71	24½	24½	10½	10½	18½	-	2	0	10½	18½	13	-	-
7' LUXE LEFT-ARM SOFA	84	44	30¾	30¾	20¾	30¾	4½	19	12¾	71	29½	29½	10½	10½	18½	-	2	0	10½	18½	13	-	-

KENSINGTON COLLECTION



All dimensions are given in inches. See the attached "Dimensions Diagram" sheet for more information on the keys used in this chart.

	OVERALL WIDTH A	OVERALL DEPTH B	OVERALL HEIGHT C	FRAME HEIGHT D	SEAT HEIGHT E	ARM HEIGHT F	FOOT HEIGHT G	SEAT HEIGHT (FLOOR TO CUSHION SEAM) H	SEAT HEIGHT (FLOOR TO FRAME) I	INSIDE SEAT WIDTH J	INSIDE SEAT DEPTH W/ BACK CUSHION K	INSIDE SEAT DEPTH W/O BACK CUSHION L	INSIDE BACK HEIGHT W/ SEAT & BACK CUSHIONS M	INSIDE BACK HEIGHT W/ SEAT CUSHION N	# OF BACK CUSHIONS	# OF SEAT CUSHIONS	ACCENT PILLOWS	ARM HEIGHT W/ SEAT CUSHION O	ARM HEIGHT W/O SEAT CUSHION P	ARM WIDTH Q	SLEEPER DEPTH OVERALL R	SLEEPER DEPTH INSIDE S	
7' LUXE RIGHT-ARM SOFA	84	44	30¾	30¾	20¾	30¾	4½	19	12¾	71	29½	29½	10½	10½	18½	-	2	0	10½	18½	13	-	-
8' PETITE LEFT-ARM SOFA	96	33¾	29½	29½	19¾	29½	4½	18¾	12	86½	24½	24½	9¾	9¾	17½	-	2	0	9¾	17½	9½	-	-
8' PETITE RIGHT-ARM SOFA	96	33¾	29½	29½	19¾	29½	4½	18¾	12	86½	24½	24½	9¾	9¾	17½	-	2	0	9¾	17½	9½	-	-
8' CLASSIC LEFT-ARM SOFA	96	38	30¾	30¾	20¾	30¾	4½	19	12¾	83	24½	24½	10½	10½	18½	-	2	0	10½	18½	13	-	-
8' CLASSIC RIGHT-ARM SOFA	96	38	30¾	30¾	20¾	30¾	4½	19	12¾	83	24½	24½	10½	10½	18½	-	2	0	10½	18½	13	-	-
8' LUXE LEFT-ARM SOFA	96	44	30¾	30¾	20¾	30¾	4½	19	12¾	83	29½	29½	10½	10½	18½	-	2	0	10½	18½	13	-	-
8' LUXE RIGHT-ARM SOFA	96	44	30¾	30¾	20¾	30¾	4½	19	12¾	83	29½	29½	10½	10½	18½	-	2	0	10½	18½	13	-	-
9' PETITE LEFT-ARM SOFA	108	33¾	29½	29½	19¾	29½	4½	18¾	12	98½	24½	24½	9¾	9¾	17½	-	3	0	9¾	17½	9½	-	-
9' PETITE RIGHT-ARM SOFA	108	33¾	29½	29½	19¾	29½	4½	18¾	12	98½	24½	24½	9¾	9¾	17½	-	3	0	9¾	17½	9½	-	-
9' CLASSIC LEFT-ARM SOFA	108	38	30¾	30¾	20¾	30¾	4½	19	12¾	95	24½	24½	10½	10½	18½	-	3	0	10½	18½	13	-	-
9' CLASSIC RIGHT-ARM SOFA	108	38	30¾	30¾	20¾	30¾	4½	19	12¾	95	24½	24½	10½	10½	18½	-	3	0	10½	18½	13	-	-
9' LUXE LEFT-ARM SOFA	108	44	30¾	30¾	20¾	30¾	4½	19	12¾	95	29½	29½	10½	10½	18½	-	3	0	10½	18½	13	-	-
9' LUXE RIGHT-ARM SOFA	108	44	30¾	30¾	20¾	30¾	4½	19	12¾	95	29½	29½	10½	10½	18½	-	3	0	10½	18½	13	-	-
10' CLASSIC LEFT-ARM SOFA	120	38	30¾	30¾	20¾	30¾	4½	19	12¾	107	24½	24½	10½	10½	18½	-	3	0	10½	18½	13	-	-

KENSINGTON COLLECTION



All dimensions are given in inches. See the attached "Dimensions Diagram" sheet for more information on the keys used in this chart.

	OVERALL WIDTH A	OVERALL DEPTH B	OVERALL HEIGHT C	FRAME HEIGHT D	SEAT HEIGHT E	ARM HEIGHT F	FOOT HEIGHT G	SEAT HEIGHT (FLOOR TO CUSHION SEAM) H	SEAT HEIGHT (FLOOR TO FRAME) I	INSIDE SEAT WIDTH J	INSIDE SEAT DEPTH W/ BACK CUSHION K	INSIDE SEAT DEPTH W/O BACK CUSHION L	INSIDE BACK HEIGHT W/ SEAT & BACK CUSHIONS M	INSIDE BACK HEIGHT W/ SEAT CUSHION N	# OF BACK CUSHIONS	# OF SEAT CUSHIONS	ACCENT PILLOWS	ARM HEIGHT W/ SEAT CUSHION O	ARM HEIGHT W/O SEAT CUSHION P	ARM WIDTH Q	SLEEPER DEPTH OVERALL R	SLEEPER DEPTH INSIDE S	
10' CLASSIC RIGHT-ARM SOFA	120	38	30¾	30¾	20¾	30¾	4½	19	12¾	107	24½	24½	10½	10½	18½	-	3	0	10½	18½	13	-	-
10' LUXE LEFT-ARM SOFA	120	44	30¾	30¾	20¾	30¾	4½	19	12¾	107	29½	29½	10½	10½	18½	-	3	0	10½	18½	13	-	-
10' LUXE RIGHT-ARM SOFA	120	44	30¾	30¾	20¾	30¾	4½	19	12¾	107	29½	29½	10½	10½	18½	-	3	0	10½	18½	13	-	-
7' PETITE LEFT-ARM RETURN SOFA	84	33¾	29½	29½	19¾	29½	4½	18¾	12	65	24½	24½	9¾	9¾	17½	-	2	0	9¾	17½	9½	-	-
7' PETITE RIGHT-ARM RETURN SOFA	84	33¾	29½	29½	19¾	29½	4½	18¾	12	65	24½	24½	9¾	9¾	17½	-	2	0	9¾	17½	9½	-	-
7' CLASSIC LEFT-ARM RETURN SOFA	84	38	30¾	30¾	20¾	30¾	4½	19	12¾	58	24½	24½	10½	10½	18½	-	2	0	10½	18½	13	-	-
7' CLASSIC RIGHT-ARM RETURN SOFA	84	38	30¾	30¾	20¾	30¾	4½	19	12¾	58	24½	24½	10½	10½	18½	-	2	0	10½	18½	13	-	-
7' LUXE LEFT-ARM RETURN SOFA	84	44	30¾	30¾	20¾	30¾	4½	19	12¾	58	29½	29½	10½	10½	18½	-	2	0	10½	18½	13	-	-
7' LUXE RIGHT-ARM RETURN SOFA	84	44	30¾	30¾	20¾	30¾	4½	19	12¾	58	29½	29½	10½	10½	18½	-	2	0	10½	18½	13	-	-
8' PETITE LEFT-ARM RETURN SOFA	96	33¾	29½	29½	19¾	29½	4½	18¾	12	77	24½	24½	9¾	9¾	17½	-	2	0	9¾	17½	9½	-	-
8' PETITE RIGHT-ARM RETURN SOFA	96	33¾	29½	29½	19¾	29½	4½	18¾	12	77	24½	24½	9¾	9¾	17½	-	2	0	9¾	17½	9½	-	-
8' CLASSIC LEFT-ARM RETURN SOFA	96	38	30¾	30¾	20¾	30¾	4½	19	12¾	69¾	24½	24½	10½	10½	18½	-	2	0	10½	18½	13	-	-
8' CLASSIC RIGHT-ARM RETURN SOFA	96	38	30¾	30¾	20¾	30¾	4½	19	12¾	69¾	24½	24½	10½	10½	18½	-	2	0	10½	18½	13	-	-
8' LUXE LEFT-ARM RETURN SOFA	96	44	30¾	30¾	20¾	30¾	4½	19	12¾	69¾	29½	29½	10½	10½	18½	-	2	0	10½	18½	13	-	-

KENSINGTON COLLECTION



All dimensions are given in inches. See the attached "Dimensions Diagram" sheet for more information on the keys used in this chart.

	OVERALL WIDTH A	OVERALL DEPTH B	OVERALL HEIGHT C	FRAME HEIGHT D	SEAT HEIGHT E	ARM HEIGHT F	FOOT HEIGHT G	SEAT HEIGHT (FLOOR TO CUSHION SEAM) H	SEAT HEIGHT (FLOOR TO FRAME) I	INSIDE SEAT WIDTH J	INSIDE SEAT DEPTH W/ BACK CUSHION K	INSIDE SEAT DEPTH W/O BACK CUSHION L	INSIDE BACK HEIGHT W/ SEAT & BACK CUSHIONS M	INSIDE BACK HEIGHT W/ SEAT CUSHION N	# OF BACK CUSHIONS	# OF SEAT CUSHIONS	ACCENT PILLOWS	ARM HEIGHT W/ SEAT CUSHION O	ARM HEIGHT W/O SEAT CUSHION P	ARM WIDTH Q	SLEEPER DEPTH OVERALL R	SLEEPER DEPTH INSIDE S	
8' LUXE RIGHT-ARM RETURN SOFA	96	44	30¾	30¾	20¾	30¾	4½	19	12¾	69¾	29½	29½	10½	10½	18½	-	2	0	10½	18½	13	-	-
9' PETITE LEFT-ARM RETURN SOFA	108	33¾	29½	29½	19¾	29½	4½	18¾	12	88	24½	24½	9¾	9¾	17½	-	3	0	9¾	17½	9½	-	-
9' PETITE RIGHT-ARM RETURN SOFA	108	33¾	29½	29½	19¾	29½	4½	18¾	12	88	24½	24½	9¾	9¾	17½	-	3	0	9¾	17½	9½	-	-
9' CLASSIC LEFT-ARM RETURN SOFA	108	38	30¾	30¾	20¾	30¾	4½	19	12¾	81¾	24½	24½	10½	10½	18½	-	2	0	10½	18½	13	-	-
9' CLASSIC RIGHT-ARM RETURN SOFA	108	38	30¾	30¾	20¾	30¾	4½	19	12¾	81¾	24½	24½	10½	10½	18½	-	2	0	10½	18½	13	-	-
9' LUXE LEFT-ARM RETURN SOFA	108	44	30¾	30¾	20¾	30¾	4½	19	12¾	81¾	29½	29½	10½	10½	18½	-	2	0	10½	18½	13	-	-
9' LUXE RIGHT-ARM RETURN SOFA	108	44	30¾	30¾	20¾	30¾	4½	19	12¾	81¾	29½	29½	10½	10½	18½	-	2	0	10½	18½	13	-	-
10' CLASSIC LEFT-ARM RETURN SOFA	120	38	30¾	30¾	20¾	30¾	4½	19	12¾	93¾	24½	24½	10½	10½	18½	-	2	0	10½	18½	13	-	-
10' CLASSIC RIGHT-ARM RETURN SOFA	120	38	30¾	30¾	20¾	30¾	4½	19	12¾	93¾	24½	24½	10½	10½	18½	-	2	0	10½	18½	13	-	-
10' LUXE LEFT-ARM RETURN SOFA	120	44	30¾	30¾	20¾	30¾	4½	19	12¾	93¾	29½	29½	10½	10½	18½	-	2	0	10½	18½	13	-	-
10' LUXE RIGHT-ARM RETURN SOFA	120	44	30¾	30¾	20¾	30¾	4½	19	12¾	93¾	29½	29½	10½	10½	18½	-	2	0	10½	18½	13	-	-
PETITE LEFT-ARM CHAISE	34	66	29½	29½	19¾	29½	4½	18¾	12	24½	56¾	56¾	9¾	9¾	17½	-	1	0	9¾	17½	9½	-	-
PETITE RIGHT-ARM CHAISE	34	66	29½	29½	19¾	29½	4½	18¾	12	24½	56¾	56¾	9¾	9¾	17½	-	1	0	9¾	17½	9½	-	-
CLASSIC LEFT-ARM CHAISE	38	70	30¾	30¾	20¾	30¾	4½	19	12¾	25	56½	56½	10½	10½	18½	-	1	0	10½	18½	13	-	-

KENSINGTON COLLECTION



All dimensions are given in inches. See the attached "Dimensions Diagram" sheet for more information on the keys used in this chart.

	A	B	C	D	E	F	G	H	I	J	K	L		M	N				O	P	Q	R	S
	OVERALL WIDTH	OVERALL DEPTH	OVERALL HEIGHT	FRAME HEIGHT	SEAT HEIGHT	ARM HEIGHT	FOOT HEIGHT	SEAT HEIGHT (FLOOR TO CUSHION SEAM)	SEAT HEIGHT (FLOOR TO FRAME)	INSIDE SEAT WIDTH	INSIDE SEAT DEPTH W/ BACK CUSHION	INSIDE SEAT DEPTH W/O BACK CUSHION	INSIDE BACK HEIGHT W/ SEAT & BACK CUSHIONS	INSIDE BACK HEIGHT W/ SEAT CUSHION	INSIDE BACK HEIGHT W/O SEAT OR BACK CUSHION	# OF BACK CUSHIONS	# OF SEAT CUSHIONS	ACCENT PILLOWS	ARM HEIGHT W/ SEAT CUSHION	ARM HEIGHT W/O SEAT CUSHION	ARM WIDTH	SLEEPER DEPTH OVERALL	SLEEPER DEPTH INSIDE
CLASSIC RIGHT-ARM CHAISE	38	70	30¾	30¾	20¾	30¾	4½	19	12¾	25	56½	56½	10½	10½	18½	-	1	0	10½	18½	13	-	-
LUXE LEFT-ARM CHAISE	44	74	30¾	30¾	20¾	30¾	4½	19	12¾	31	60¾	60¾	10½	10½	18½	-	1	0	10½	18½	13	-	-
LUXE RIGHT-ARM CHAISE	44	74	30¾	30¾	20¾	30¾	4½	19	12¾	31	60¾	60¾	10½	10½	18½	-	1	0	10½	18½	13	-	-

UPHOLSTERY DIMENSIONS DIAGRAM

See the "Dimensions Sheet" for the measurements that correspond with the letters below.

RH

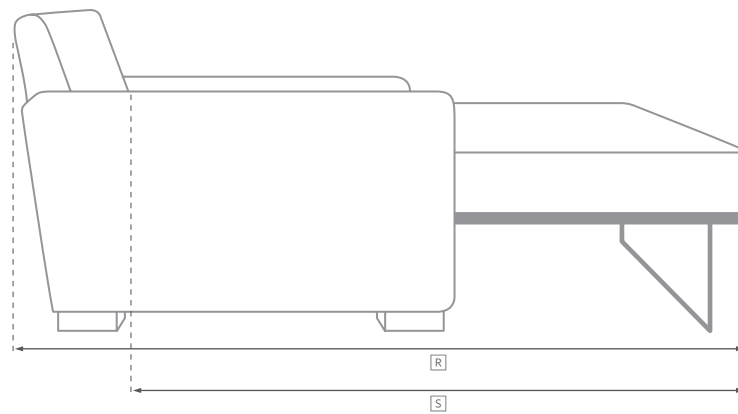
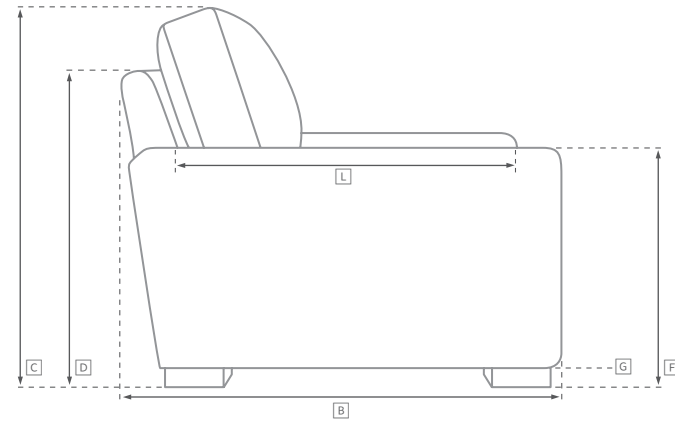
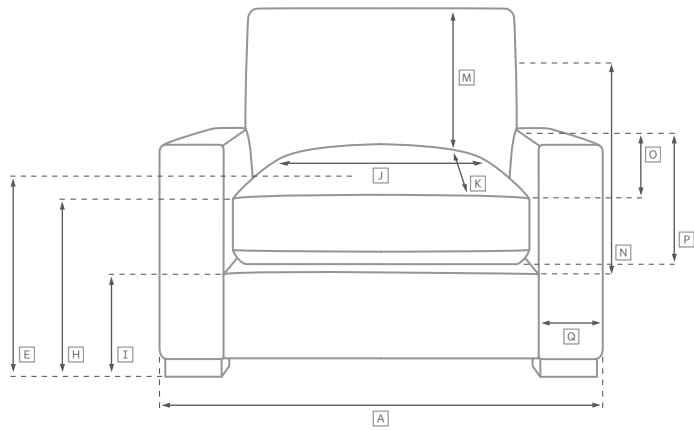

SOFA CHAISE SECTIONAL

Available in left and right-arm configurations.

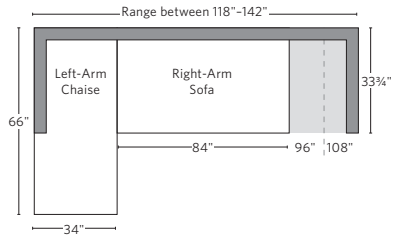

U-CHAISE SECTIONAL

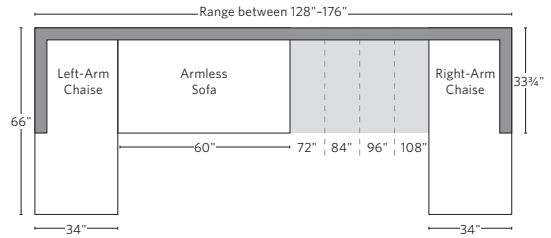

L-SECTIONAL

Available in left and right-arm configurations.

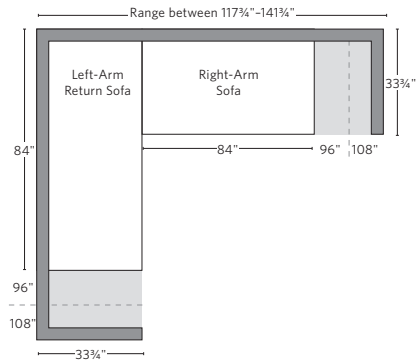

U-SOFA CHAISE SECTIONAL

Available in left and right-arm configurations.

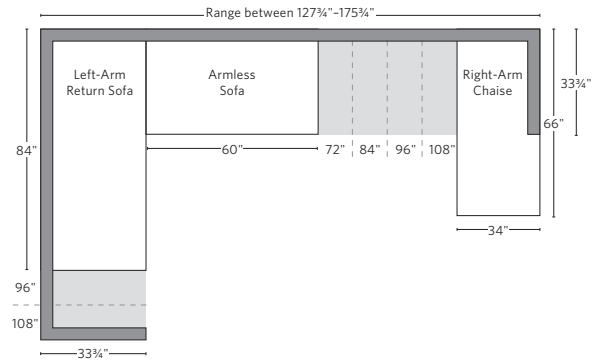

U-SOFA SECTIONAL

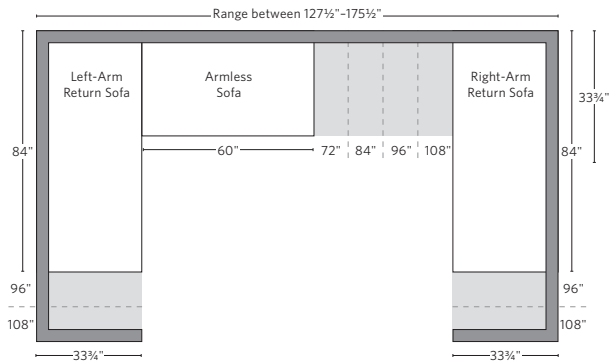

Multiple length options available.

SOFA CHAISE SECTIONAL

Available in left and right-arm configurations.

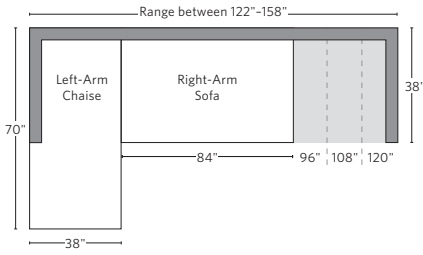

U-CHAISE SECTIONAL

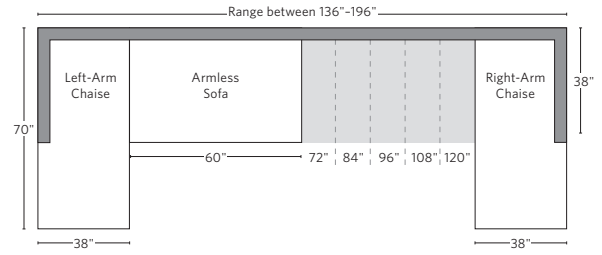

L-SECTIONAL

Available in left and right-arm configurations.

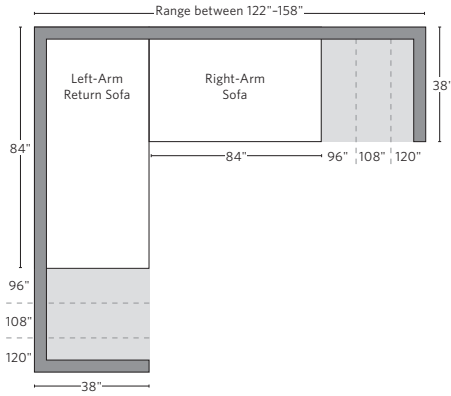

U-SOFA CHAISE SECTIONAL

Available in left and right-arm configurations.

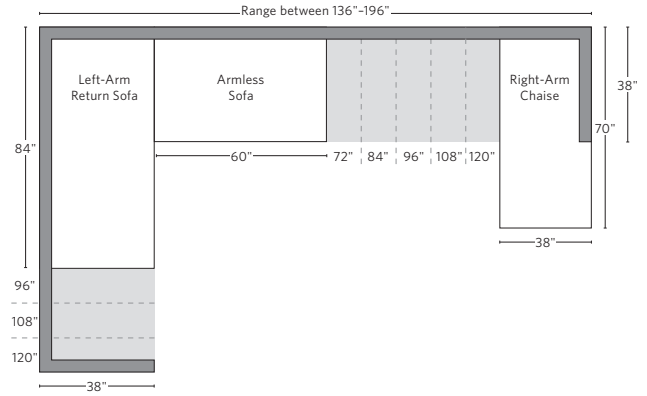

U-SOFA SECTIONAL

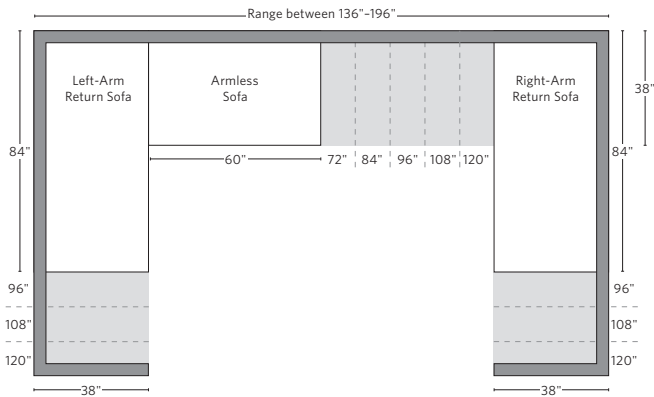

Multiple length options available.

SOFA CHAISE SECTIONAL

Available in left and right-arm configurations.

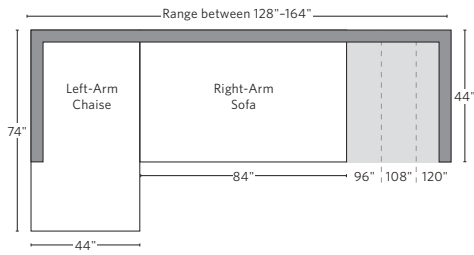

U-CHAISE SECTIONAL

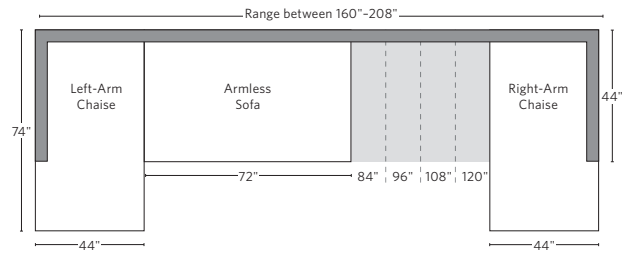

L-SECTIONAL

Available in left and right-arm configurations.

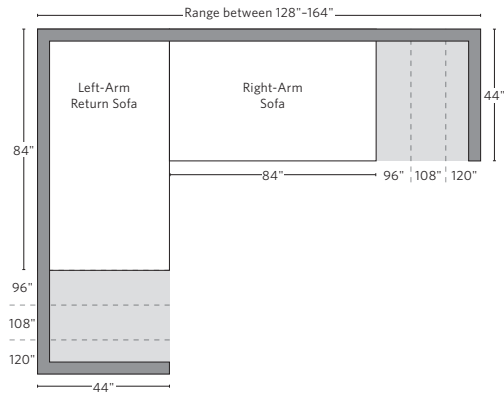

U-SOFA CHAISE SECTIONAL

Available in left and right-arm configurations.

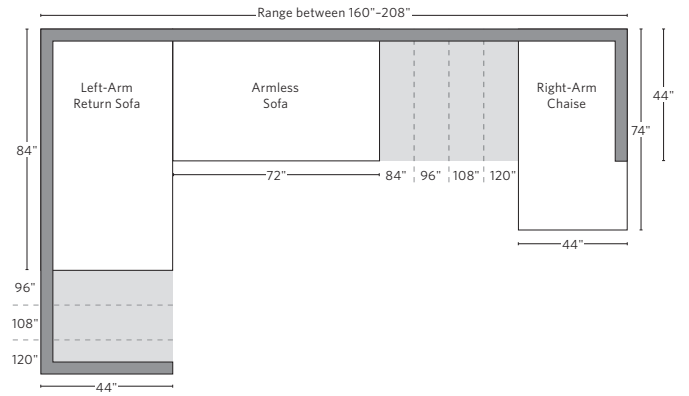

U-SOFA SECTIONAL

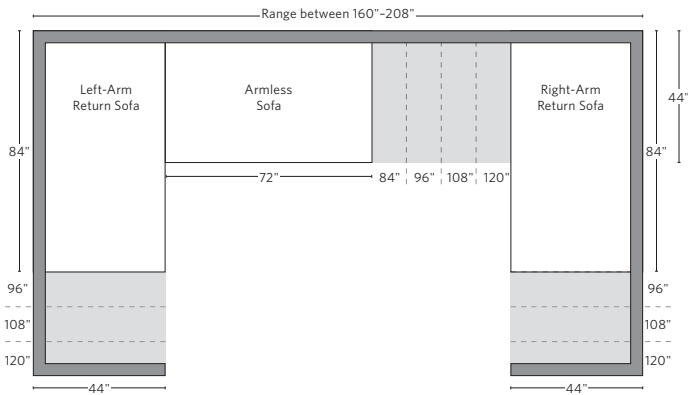

Multiple length options available.