

# BELGIAN TRACK ARM COLLECTION



All dimensions are given in inches. See the attached "Dimensions Diagram" sheet for more information on the keys used in this chart.

	A	B	C	D	E	F	G	H	I	J	K	L		M	N						O	P	Q	R	S
	OVERALL WIDTH	OVERALL DEPTH	OVERALL HEIGHT	FRAME HEIGHT	SEAT HEIGHT	ARM HEIGHT	FOOT HEIGHT	SEAT HEIGHT (FLOOR TO CUSHION SEAM)	SEAT HEIGHT (FLOOR TO FRAME)	INSIDE SEAT WIDTH	INSIDE SEAT DEPTH W/ BACK CUSHION	INSIDE SEAT DEPTH W/O BACK CUSHION	INSIDE BACK HEIGHT W/ SEAT & BACK CUSHIONS	INSIDE BACK HEIGHT W/ SEAT CUSHION	INSIDE BACK HEIGHT W/O SEAT OR BACK CUSHION	# OF BACK CUSHIONS	# OF SEAT CUSHIONS	ACCENT PILLOWS	REGULAR ACCENT PILLOWS DIAMETER	LARGER ACCENT PILLOW DIAMETER	ARM HEIGHT W/ SEAT CUSHION	ARM HEIGHT W/O SEAT CUSHION	ARM WIDTH	SLEEPER DEPTH OVERALL	SLEEPER DEPTH INSIDE
5' PETITE SOFA*	60	34	28	28	16½	21½	2	14½	10	52½	20	27½	11½	11½	18	2	2	0	-	-	5	11½	3¾	-	-
5' CLASSIC SOFA*	60	37¾	32¾	30¾	19¾	23¾	2	18¾	12¾	50	22¾	29	12½	11	18½	2	2	0	-	-	4	11½	5	-	-
5' LUXE SOFA*	60	43¾	34	32	20½	24¾	2	19½	13	49½	25½	35	13½	11½	19	2	2	0	-	-	3¾	11¼	5¼	-	-
6' PETITE SOFA*	72	34	28	28	16½	21½	2	14½	10	64½	20	27½	11½	11½	18	2	2	0	-	-	5	11½	3¾	-	-
6' CLASSIC SOFA*	72	37¾	32¾	30¾	19¾	23¾	2	18¾	12¾	62	22¾	29	12½	11	18½	2	2	2	-	-	4	11½	5	-	-
6' LUXE SOFA*	72	43¾	34	32	20½	24¾	2	19½	13	61½	25½	35	13½	11½	19	2	2	2	-	-	3¾	11¼	5¼	-	-
84" QUEEN SLEEPER SOFA	84	40	36	34	20	25	1¾	17	12	75	23	32	16	14	22	2	1	0	-	-	5	13	4½	85	80
7' PETITE SOFA*	84	34	28	28	16½	21½	2	14½	10	76½	20	27½	11½	11½	18	2	2	0	-	-	5	11½	3¾	-	-
7' CLASSIC SOFA*	84	37¾	32¾	30¾	19¾	23¾	2	18¾	12¾	74	22¾	29	12½	11	18½	2	2	2	-	-	4	11½	5	-	-
7' CLASSIC SOFA	84	37¾	32¾	30¾	19¾	23¾	2	18¾	12¾	72	22¾	29	12½	11	18½	2	2	2	-	-	4	11½	5	-	-
7' LUXE SOFA*	84	43¾	34	32	20½	24¾	2	19½	13	73½	25½	35	13½	11½	19	2	2	2	-	-	3¾	11¼	5¼	-	-
7' LUXE SOFA	84	43¾	34	32	20½	24¾	2	19½	13	73½	25½	35	13½	11½	19	2	2	2	-	-	3¾	11¼	5¼	-	-
8' PETITE SOFA*	96	34	28	28	16½	21½	2	14½	10	88½	20	27½	11½	11½	18	2	2	0	-	-	5	11½	3¾	-	-

\* ALSO AVAILABLE WITH 1 SEAT CUSHION

# BELGIAN TRACK ARM COLLECTION



All dimensions are given in inches. See the attached "Dimensions Diagram" sheet for more information on the keys used in this chart.

	A	B	C	D	E	F	G	H	I	J	K	L		M	N											
	OVERALL WIDTH	OVERALL DEPTH	OVERALL HEIGHT	FRAME HEIGHT	SEAT HEIGHT	ARM HEIGHT	FOOT HEIGHT	SEAT HEIGHT (FLOOR TO CUSHION SEAM)	SEAT HEIGHT (FLOOR TO FRAME)	INSIDE SEAT WIDTH	INSIDE SEAT DEPTH W/ BACK CUSHION	INSIDE SEAT DEPTH W/O BACK CUSHION	INSIDE BACK HEIGHT W/ SEAT & BACK CUSHIONS	INSIDE BACK HEIGHT W/ SEAT CUSHION	INSIDE BACK HEIGHT W/O SEAT OR BACK CUSHION	# OF BACK CUSHIONS	# OF SEAT CUSHIONS	ACCENT PILLOWS	REGULAR ACCENT PILLOWS DIAMETER	LARGER ACCENT PILLOW DIAMETER	ARM HEIGHT W/ SEAT CUSHION	ARM HEIGHT W/O SEAT CUSHION	ARM WIDTH	SLEEPER DEPTH OVERALL	SLEEPER DEPTH INSIDE	
8' CLASSIC SOFA*	96	37½	32¼	30¾	19¾	23¾	2	18¾	12¼	86	22¼	29	12½	11	18½	2	2	2	-	-	4	11½	5	-	-	
8' CLASSIC SOFA*	96	37½	32¼	30¾	19¾	23¾	2	18¾	12¼	84	22¼	29	12½	11	18½	2	2	2	-	-	4	11½	5	-	-	
8' LUXE SOFA*	96	43¾	34	32	20½	24¼	2	19½	13	85½	25½	35	13½	11½	19	2	2	2	-	-	3¾	11¼	5¼	-	-	
8' LUXE SOFA*	96	43¾	34	32	20½	24¼	2	19½	13	85½	25½	35	13½	11½	19	2	2	2	-	-	3¾	11¼	5¼	-	-	
96" KING SLEEPER SOFA	96	40	36	34	20	25	1¾	17	12	87	23	32	16	14	22	2	1	0	-	-	5	13	4½	85	80	
9' PETITE SOFA*	108	34	28	28	16½	21½	2	14½	10	100½	20	27½	11½	11½	18	2	2	0	-	-	5	11½	3¾	-	-	
9' CLASSIC SOFA*	108	37½	32¼	30¾	19¾	23¾	2	18¾	12¼	98	22¼	29	12½	11	18½	2	2	2	-	-	4	11½	5	-	-	
9' CLASSIC SOFA *	108	37½	32¼	30¾	19¾	23¾	2	18¾	12¼	96	22¼	29	12½	11	18½	2	2	2	-	-	4	11½	5	-	-	
9' LUXE SOFA*	108	43¾	34	32	20½	24¼	2	19½	13	97½	25½	35	13½	11½	19	2	2	2	-	-	3¾	11¼	5¼	-	-	
9' LUXE SOFA*	108	43¾	34	32	20½	24¼	2	19½	13	97½	25½	35	13½	11½	19	2	2	2	-	-	3¾	11¼	5¼	-	-	
108" KING SLEEPER SOFA	108	40	36	34	20	25	1¾	17	12	99	23	32	16	14	22	2	1	0	-	-	5	13	4½	85	80	
10' PETITE SOFA*	120	34	28	28	16½	21½	2	14½	10	112½	20	27½	11½	11½	18	2	2	0	-	-	5	11½	3¾	-	-	
10' CLASSIC SOFA*	120	37½	32¼	30¾	19¾	23¾	2	18¾	12¼	110	22¼	29	12½	11	18½	2	2	2	-	-	4	11½	5	-	-	

\* ALSO AVAILABLE WITH 1 SEAT CUSHION

# BELGIAN TRACK ARM COLLECTION



All dimensions are given in inches. See the attached "Dimensions Diagram" sheet for more information on the keys used in this chart.

	A	B	C	D	E	F	G	H	I	J	K	L		M	N						O	P	Q	R	S
	OVERALL WIDTH	OVERALL DEPTH	OVERALL HEIGHT	FRAME HEIGHT	SEAT HEIGHT	ARM HEIGHT	FOOT HEIGHT	SEAT HEIGHT (FLOOR TO CUSHION SEAM)	SEAT HEIGHT (FLOOR TO FRAME)	INSIDE SEAT WIDTH	INSIDE SEAT DEPTH W/ BACK CUSHION	INSIDE SEAT DEPTH W/O BACK CUSHION	INSIDE BACK HEIGHT W/ SEAT & BACK CUSHIONS	INSIDE BACK HEIGHT W/ SEAT CUSHION	INSIDE BACK HEIGHT W/O SEAT OR BACK CUSHION	# OF BACK CUSHIONS	# OF SEAT CUSHIONS	ACCENT PILLOWS	REGULAR ACCENT PILLOWS DIAMETER	LARGER ACCENT PILLOW DIAMETER	ARM HEIGHT W/ SEAT CUSHION	ARM HEIGHT W/O SEAT CUSHION	ARM WIDTH	SLEEPER DEPTH OVERALL	SLEEPER DEPTH INSIDE
10' LUXE SOFA*	120	43¾	34	32	20½	24¾	2	19½	13	109½	25½	35	13¾	11½	19	2	2	2	-	-	3¾	11¾	5¾	-	-
PETTE CHAIR	31	34	28	28	16½	21½	2	14½	10	23¾	20	27½	11¾	11½	18	1	1	0	-	-	5	11¾	3¾	-	-
CLASSIC CHAIR	35	37¾	32¾	30¾	19¾	23¾	2	18¾	12¾	25	22¾	29	12½	11	18½	1	1	0	-	-	4	11½	5	-	-
LUXE CHAIR	40	43¾	34	32	20½	24¾	2	19½	13	29½	25½	35	13¾	11½	19	1	1	0	-	-	3¾	11¾	5¾	-	-
PETTE CHAIR-AND-A-HALF	50	34	28	28	16½	21½	2	14½	10	42½	20	27½	11¾	11½	18	1	1	0	-	-	5	11¾	3¾	-	-
CLASSIC CHAIR-AND-A-HALF	50	37¾	32¾	30¾	19¾	23¾	2	18¾	12¾	40	22¾	29	12½	11	18½	1	1	0	-	-	4	11½	5	-	-
LUXE CHAIR-AND-A-HALF	50	43¾	34	32	20½	24¾	2	19½	13	39½	25½	35	13¾	11½	19	1	1	0	-	-	3¾	11¾	5¾	-	-
CLASSIC SWIVEL CHAIR	35	37¾	32¾	30¾	19¾	23¾	2	18¾	12¾	25	22¾	29	12½	11	18½	1	1	0	-	-	4	11½	5	-	-
LUXE SWIVEL CHAIR	40	43¾	34	32	20½	24¾	2	19½	13	29½	25½	35	13¾	11½	19	1	1	0	-	-	3¾	11¾	5¾	-	-
CHAISE	40	73½	34	32	20½	24¾	2	19½	13	29¾	57¾	65¾	13¾	11½	19	1	1	0	-	-	3¾	11¾	5	-	-
DAYBED	96	60	34	32	20½	24¾	2	19½	13	86	25½	35	13¾	11½	19	2	1	2	-	-	3¾	11¾	5½	-	-
PETTE OTTOMAN	31	31	16	10	16	-	2	16	10	31	-	-	-	-	-	-	1	-	-	-	-	-	-	-	-
LUXE OTTOMAN	40	33	20½	20½	20½	-	2	19	12¾	40	-	-	-	-	-	-	1	-	-	-	-	-	-	-	-

\* ALSO AVAILABLE WITH 1 SEAT CUSHION



# BELGIAN TRACK ARM COLLECTION



All dimensions are given in inches. See the attached "Dimensions Diagram" sheet for more information on the keys used in this chart.

	OVERALL WIDTH [A]	OVERALL DEPTH [B]	OVERALL HEIGHT [C]	FRAME HEIGHT [D]	SEAT HEIGHT [E]	ARM HEIGHT [F]	FOOT HEIGHT [G]	SEAT HEIGHT (FLOOR TO CUSHION SEAM) [H]	SEAT HEIGHT (FLOOR TO FRAME) [I]	INSIDE SEAT WIDTH [J]	INSIDE SEAT DEPTH W/ BACK CUSHION [K]	INSIDE SEAT DEPTH W/O BACK CUSHION [L]	INSIDE BACK HEIGHT W/ SEAT & BACK CUSHIONS [M]	INSIDE BACK HEIGHT W/ SEAT CUSHION [N]	# OF BACK CUSHIONS	# OF SEAT CUSHIONS	ACCENT PILLOWS	REGULAR ACCENT PILLOWS DIAMETER	LARGER ACCENT PILLOW DIAMETER	ARM HEIGHT W/ SEAT CUSHION [O]	ARM HEIGHT W/O SEAT CUSHION [P]	ARM WIDTH [Q]	SLEEPER DEPTH OVERALL [R]	SLEEPER DEPTH INSIDE [S]	
9' CLASSIC ARMLESS SOFA*	108	37¾	32¾	30¾	19¾	-	2	18¾	12¾	108	22¾	29	12½	11	18½	2	2	0	-	-	-	-	-	-	-
9' LUXE ARMLESS SOFA*	108	43¾	34	32	20½	-	2	19½	13	108	25½	35	13½	11½	19	2	2	0	-	-	-	-	-	-	-
10' LUXE ARMLESS SOFA*	120	43¾	34	32	20½	-	2	19½	13	120	25½	35	13½	11½	19	2	2	0	-	-	-	-	-	-	-
5' PETTIE LEFT-ARM SOFA*	60	34	28	28	16½	21½	2	14½	10	56¾	20	27½	11½	11½	18	2	2	0	-	-	5	11½	3¾	-	-
5' PETTIE RIGHT-ARM SOFA*	60	34	28	28	16½	21½	2	14½	10	56¾	20	27½	11½	11½	18	2	2	0	-	-	5	11½	3¾	-	-
5' CLASSIC LEFT-ARM SOFA*	60	37¾	32¾	30¾	19¾	23¾	2	18¾	12¾	55	22¾	29	12½	11	18½	2	2	0	-	-	4	11½	5	-	-
5' CLASSIC RIGHT-ARM SOFA*	60	37¾	32¾	30¾	19¾	23¾	2	18¾	12¾	55	22¾	29	12½	11	18½	2	2	0	-	-	4	11½	5	-	-
6' PETTIE LEFT-ARM SOFA*	72	34	28	28	16½	21½	2	14½	10	68¾	20	27½	11½	11½	18	2	2	0	-	-	5	11½	3¾	-	-
6' PETTIE RIGHT-ARM SOFA*	72	34	28	28	16½	21½	2	14½	10	68¾	20	27½	11½	11½	18	2	2	0	-	-	5	11½	3¾	-	-
6' CLASSIC LEFT-ARM SOFA*	72	37¾	32¾	30¾	19¾	23¾	2	18¾	12¾	67	22¾	29	12½	11	18½	2	2	0	-	-	4	11½	5	-	-
6' CLASSIC RIGHT-ARM SOFA*	72	37¾	32¾	30¾	19¾	23¾	2	18¾	12¾	67	22¾	29	12½	11	18½	2	2	0	-	-	4	11½	5	-	-
6' LUXE LEFT-ARM SOFA*	72	43¾	34	32	20½	24¾	2	19½	13	66¾	25½	35	13½	11½	19	2	2	0	-	-	3¾	11¼	5¼	-	-
6' LUXE RIGHT-ARM SOFA*	72	43¾	34	32	20½	24¾	2	19½	13	66¾	25½	35	13½	11½	19	2	2	0	-	-	3¾	11¼	5¼	-	-

\* ALSO AVAILABLE WITH 1 SEAT CUSHION

# BELGIAN TRACK ARM COLLECTION



All dimensions are given in inches. See the attached "Dimensions Diagram" sheet for more information on the keys used in this chart.

	A	B	C	D	E	F	G	H	I	J	K	L		M	N						O	P	Q	R	S
	OVERALL WIDTH	OVERALL DEPTH	OVERALL HEIGHT	FRAME HEIGHT	SEAT HEIGHT	ARM HEIGHT	FOOT HEIGHT	SEAT HEIGHT (FLOOR TO CUSHION SEAM)	SEAT HEIGHT (FLOOR TO FRAME)	INSIDE SEAT WIDTH	INSIDE SEAT DEPTH W/ BACK CUSHION	INSIDE SEAT DEPTH W/O BACK CUSHION	INSIDE BACK HEIGHT W/ SEAT & BACK CUSHIONS	INSIDE BACK HEIGHT W/ SEAT CUSHION	INSIDE BACK HEIGHT W/O SEAT OR BACK CUSHION	# OF BACK CUSHIONS	# OF SEAT CUSHIONS	ACCENT PILLOWS	REGULAR ACCENT PILLOWS DIAMETER	LARGER ACCENT PILLOW DIAMETER	ARM HEIGHT W/ SEAT CUSHION	ARM HEIGHT W/O SEAT CUSHION	ARM WIDTH	SLEEPER DEPTH OVERALL	SLEEPER DEPTH INSIDE
7' PETITE LEFT-ARM SOFA*	84	34	28	28	16½	21½	2	14½	10	80¼	20	27½	11½	11½	18	2	2	0	-	-	5	11½	3¾	-	-
7' PETITE RIGHT-ARM SOFA*	84	34	28	28	16½	21½	2	14½	10	80¼	20	27½	11½	11½	18	2	2	0	-	-	5	11½	3¾	-	-
7' CLASSIC LEFT-ARM SOFA*	84	37¼	32¼	30¾	19¾	23¾	2	18¾	12¼	79	22¼	29	12½	11	18½	2	2	0	-	-	4	11½	5	-	-
7' CLASSIC RIGHT-ARM SOFA*	84	37¼	32¼	30¾	19¾	23¾	2	18¾	12¼	79	22¼	29	12½	11	18½	2	2	0	-	-	4	11½	5	-	-
7' LUXE LEFT-ARM SOFA*	84	43¾	34	32	20½	24¾	2	19½	13	78¾	25½	35	13½	11½	19	2	2	0	-	-	3¾	11¾	5¾	-	-
7' LUXE RIGHT-ARM SOFA*	84	43¾	34	32	20½	24¾	2	19½	13	78¾	25½	35	13½	11½	19	2	2	0	-	-	3¾	11¾	5¾	-	-
8' PETITE LEFT-ARM SOFA*	96	34	28	28	16½	21½	2	14½	10	92¼	20	27½	11½	11½	18	2	2	0	-	-	5	11½	3¾	-	-
8' PETITE RIGHT-ARM SOFA*	96	34	28	28	16½	21½	2	14½	10	92¼	20	27½	11½	11½	18	2	2	0	-	-	5	11½	3¾	-	-
8' CLASSIC LEFT-ARM SOFA*	96	37¼	32¼	30¾	19¾	23¾	2	18¾	12¼	91	22¼	29	12½	11	18½	2	2	0	-	-	4	11½	5	-	-
8' CLASSIC RIGHT-ARM SOFA*	96	37¼	32¼	30¾	19¾	23¾	2	18¾	12¼	91	22¼	29	12½	11	18½	2	2	0	-	-	4	11½	5	-	-
8' LUXE LEFT-ARM SOFA*	96	43¾	34	32	20½	24¾	2	19½	13	90¾	25½	35	13½	11½	19	2	2	0	-	-	3¾	11¾	5¾	-	-
8' LUXE RIGHT-ARM SOFA*	96	43¾	34	32	20½	24¾	2	19½	13	90¾	25½	35	13½	11½	19	2	2	0	-	-	3¾	11¾	5¾	-	-
9' PETITE LEFT-ARM SOFA*	108	34	28	28	16½	21½	2	14½	10	104½	20	27½	11½	11½	18	2	2	0	-	-	5	11½	3¾	-	-

\* ALSO AVAILABLE WITH 1 SEAT CUSHION

# BELGIAN TRACK ARM COLLECTION



All dimensions are given in inches. See the attached "Dimensions Diagram" sheet for more information on the keys used in this chart.

	OVERALL WIDTH [A]	OVERALL DEPTH [B]	OVERALL HEIGHT [C]	FRAME HEIGHT [D]	SEAT HEIGHT [E]	ARM HEIGHT [F]	FOOT HEIGHT [G]	SEAT HEIGHT (FLOOR TO CUSHION SEAM) [H]	SEAT HEIGHT (FLOOR TO FRAME) [I]	INSIDE SEAT WIDTH [J]	INSIDE SEAT DEPTH W/ BACK CUSHION [K]	INSIDE SEAT DEPTH W/O BACK CUSHION [L]	INSIDE BACK HEIGHT W/ SEAT & BACK CUSHIONS [M]	INSIDE BACK HEIGHT W/ SEAT CUSHION [N]	# OF BACK CUSHIONS	# OF SEAT CUSHIONS	ACCENT PILLOWS	REGULAR ACCENT PILLOWS DIAMETER	LARGER ACCENT PILLOW DIAMETER	ARM HEIGHT W/ SEAT CUSHION [O]	ARM HEIGHT W/O SEAT CUSHION [P]	ARM WIDTH [Q]	SLEEPER DEPTH OVERALL [R]	SLEEPER DEPTH INSIDE [S]	
9' PETITE RIGHT-ARM SOFA*	108	34	28	28	16½	21½	2	14½	10	104½	20	27½	11½	11½	18	2	2	0	-	-	5	11½	3¾	-	-
9' CLASSIC LEFT-ARM SOFA*	108	37¾	32¾	30¾	19¾	23¾	2	18¾	12¼	103	22¾	29	12½	11	18½	2	2	0	-	-	4	11½	5	-	-
9' CLASSIC RIGHT-ARM SOFA*	108	37¾	32¾	30¾	19¾	23¾	2	18¾	12¼	103	22¾	29	12½	11	18½	2	2	0	-	-	4	11½	5	-	-
9' LUXE LEFT-ARM SOFA*	108	43¾	34	32	20½	24¾	2	19½	13	102¾	25½	35	13½	11½	19	2	2	0	-	-	3¾	11¼	5¼	-	-
9' LUXE RIGHT-ARM SOFA*	108	43¾	34	32	20½	24¾	2	19½	13	102¾	25½	35	13½	11½	19	2	2	0	-	-	3¾	11¼	5¼	-	-
10' LUXE LEFT-ARM SOFA*	120	43¾	34	32	20½	24¾	2	19½	13	114¾	25½	35	13½	11½	19	2	2	0	-	-	3¾	11¼	5¼	-	-
10' LUXE RIGHT-ARM SOFA*	120	43¾	34	32	20½	24¾	2	19½	13	114¾	25½	35	13½	11½	19	2	2	0	-	-	3¾	11¼	5¼	-	-
7' PETITE LEFT-ARM RETURN SOFA*	84	34	28	28	16½	21½	2	14½	10	73¾	20	27½	11½	11½	18	3	2	0	-	-	5	11½	3¾	-	-
7' PETITE RIGHT-ARM RETURN SOFA*	84	34	28	28	16½	21½	2	14½	10	73¾	20	27½	11½	11½	18	3	2	0	-	-	5	11½	3¾	-	-
7' CLASSIC LEFT-ARM RETURN SOFA*	84	37¾	32¾	30¾	19¾	23¾	2	18¾	12¼	70¾	22¾	29	12½	11	18½	3	2	0	-	-	4	11½	5	-	-
7' CLASSIC RIGHT-ARM RETURN SOFA*	84	37¾	32¾	30¾	19¾	23¾	2	18¾	12¼	70¾	22¾	29	12½	11	18½	3	2	0	-	-	4	11½	5	-	-
7' LUXE LEFT-ARM RETURN SOFA*	84	43¾	34	32	20½	24¾	2	19½	13	69¾	25½	35	13½	11½	19	3	2	0	-	-	3¾	11¼	5¼	-	-
7' LUXE RIGHT-ARM RETURN SOFA*	84	43¾	34	32	20½	24¾	2	19½	13	69¾	25½	35	13½	11½	19	3	2	0	-	-	3¾	11¼	5¼	-	-

\* ALSO AVAILABLE WITH 1 SEAT CUSHION

# BELGIAN TRACK ARM COLLECTION



All dimensions are given in inches. See the attached "Dimensions Diagram" sheet for more information on the keys used in this chart.

	OVERALL WIDTH [A]	OVERALL DEPTH [B]	OVERALL HEIGHT [C]	FRAME HEIGHT [D]	SEAT HEIGHT [E]	ARM HEIGHT [F]	FOOT HEIGHT [G]	SEAT HEIGHT (FLOOR TO CUSHION SEAM) [H]	SEAT HEIGHT (FLOOR TO FRAME) [I]	INSIDE SEAT WIDTH [J]	INSIDE SEAT DEPTH W/ BACK CUSHION [K]	INSIDE SEAT DEPTH W/O BACK CUSHION [L]	INSIDE BACK HEIGHT W/ SEAT & BACK CUSHIONS [M]	INSIDE BACK HEIGHT W/ SEAT CUSHION [N]	# OF BACK CUSHIONS	# OF SEAT CUSHIONS	ACCENT PILLOWS	REGULAR ACCENT PILLOWS DIAMETER	LARGER ACCENT PILLOW DIAMETER	ARM HEIGHT W/ SEAT CUSHION [O]	ARM HEIGHT W/O SEAT CUSHION [P]	ARM WIDTH [Q]	SLEEPER DEPTH OVERALL [R]	SLEEPER DEPTH INSIDE [S]
8' PETITE LEFT-ARM RETURN SOFA*	96	34	28	28	16½	21½	2	14½	10	85¼	20	27½	11½	11½	3	2	0	-	-	5	11½	3¾	-	-
8' PETITE RIGHT-ARM RETURN SOFA*	96	34	28	28	16½	21½	2	14½	10	85¼	20	27½	11½	11½	3	2	0	-	-	5	11½	3¾	-	-
8' CLASSIC LEFT-ARM RETURN SOFA*	96	37¾	32¾	30¾	19¾	23¾	2	18¾	12¾	82¾	22¾	29	12½	11	3	2	0	-	-	4	11½	5	-	-
8' CLASSIC RIGHT-ARM RETURN SOFA*	96	37¾	32¾	30¾	19¾	23¾	2	18¾	12¾	82¾	22¾	29	12½	11	3	2	0	-	-	4	11½	5	-	-
8' LUXE LEFT-ARM RETURN SOFA*	96	43¾	34	32	20½	24¾	2	19½	13	81¾	25½	35	13½	11½	3	2	0	-	-	3¾	11¾	5¾	-	-
8' LUXE RIGHT-ARM RETURN SOFA*	96	43¾	34	32	20½	24¾	2	19½	13	81¾	25½	35	13½	11½	3	2	0	-	-	3¾	11¾	5¾	-	-
9' PETITE LEFT-ARM RETURN SOFA*	108	34	28	28	16½	21½	2	14½	10	97¾	20	27½	11½	11½	3	2	0	-	-	5	11½	3¾	-	-
9' PETITE RIGHT-ARM RETURN SOFA*	108	34	28	28	16½	21½	2	14½	10	97¾	20	27½	11½	11½	3	2	0	-	-	5	11½	3¾	-	-
9' CLASSIC LEFT-ARM RETURN SOFA*	108	37¾	32¾	30¾	19¾	23¾	2	18¾	12¾	94¾	22¾	29	12½	11	3	2	0	-	-	4	11½	5	-	-
9' CLASSIC RIGHT-ARM RETURN SOFA*	108	37¾	32¾	30¾	19¾	23¾	2	18¾	12¾	94¾	22¾	29	12½	11	3	2	0	-	-	4	11½	5	-	-
9' LUXE LEFT-ARM RETURN SOFA*	108	43¾	34	32	20½	24¾	2	19½	13	93¾	25½	35	13½	11½	3	2	0	-	-	3¾	11¾	5¾	-	-
9' LUXE RIGHT-ARM RETURN SOFA*	108	43¾	34	32	20½	24¾	2	19½	13	93¾	25½	35	13½	11½	3	2	0	-	-	3¾	11¾	5¾	-	-
10' CLASSIC LEFT-ARM RETURN SOFA*	120	37¾	32¾	30¾	19¾	23¾	2	18¾	12¾	106½	22¾	29	12½	11	4	2	0	-	-	4	11½	5	-	-

\* ALSO AVAILABLE WITH 1 SEAT CUSHION



# BELGIAN TRACK ARM COLLECTION



All dimensions are given in inches. See the attached "Dimensions Diagram" sheet for more information on the keys used in this chart.

	A	B	C	D	E	F	G	H	I	J	K	L		M	N											
	OVERALL WIDTH	OVERALL DEPTH	OVERALL HEIGHT	FRAME HEIGHT	SEAT HEIGHT	ARM HEIGHT	FOOT HEIGHT	SEAT HEIGHT (FLOOR TO CUSHION SEAM)	SEAT HEIGHT (FLOOR TO FRAME)	INSIDE SEAT WIDTH	INSIDE SEAT DEPTH W/ BACK CUSHION	INSIDE SEAT DEPTH W/O BACK CUSHION	INSIDE BACK HEIGHT W/ SEAT & BACK CUSHIONS	INSIDE BACK HEIGHT W/ SEAT CUSHION	INSIDE BACK HEIGHT W/O SEAT OR BACK CUSHION	# OF BACK CUSHIONS	# OF SEAT CUSHIONS	ACCENT PILLOWS	REGULAR ACCENT PILLOWS DIAMETER	LARGER ACCENT PILLOW DIAMETER	ARM HEIGHT W/ SEAT CUSHION	ARM HEIGHT W/O SEAT CUSHION	ARM WIDTH	SLEEPER DEPTH OVERALL	SLEEPER DEPTH INSIDE	
10' CLASSIC RIGHT-ARM RETURN SOFA*	120	37¾	32¾	30¾	19¾	23¾	2	18¾	12¼	106½	22¾	29	12½	11	18½	4	2	0	-	-	4	11½	5	-	-	
10' LUXE LEFT-ARM RETURN SOFA*	120	43¾	34	32	20½	24¾	2	19½	13	105¾	25½	35	13½	11½	19	4	2	0	-	-	3¾	11¾	5¾	-	-	
10' LUXE RIGHT-ARM RETURN SOFA*	120	43¾	34	32	20½	24¾	2	19½	13	105¾	25½	35	13½	11½	19	4	2	0	-	-	3¾	11¾	5¾	-	-	
PETTE LEFT-ARM CHAISE	28	65	27¾	28	16½	21½	2	14½	10	24	51	59	11¾	11¾	17¾	1	1	0	-	-	5	11½	3¾	-	-	
PETTE RIGHT-ARM CHAISE	28	65	27¾	28	16½	21½	2	14½	10	24	51	59	11¾	11¾	17¾	1	1	0	-	-	5	11½	3¾	-	-	
CLASSIC LEFT-ARM CHAISE	33¾	73¾	32¾	30¾	19¾	23¾	2	18¾	12¼	29¾	55¾	65½	12½	11	18½	1	1	0	-	-	4	11½	5	-	-	
CLASSIC RIGHT-ARM CHAISE	33¾	73¾	32¾	30¾	19¾	23¾	2	18¾	12¼	29¾	55¾	65½	12½	11	18½	1	1	0	-	-	4	11½	5	-	-	
LUXE LEFT-ARM CHAISE	38	75¾	34	32	20½	24½	2	19½	13	32¾	60	68	13½	11½	19	1	1	0	-	-	4	11½	5½	-	-	
LUXE RIGHT-ARM CHAISE	38	75¾	34	32	20½	24½	2	19½	13	32¾	60	68	13½	11½	19	1	1	0	-	-	4	11½	5½	-	-	

\* ALSO AVAILABLE WITH 1 SEAT CUSHION

# UPHOLSTERY DIMENSIONS DIAGRAM

See the "Dimensions Sheet" for the measurements that correspond with the letters below.

RH

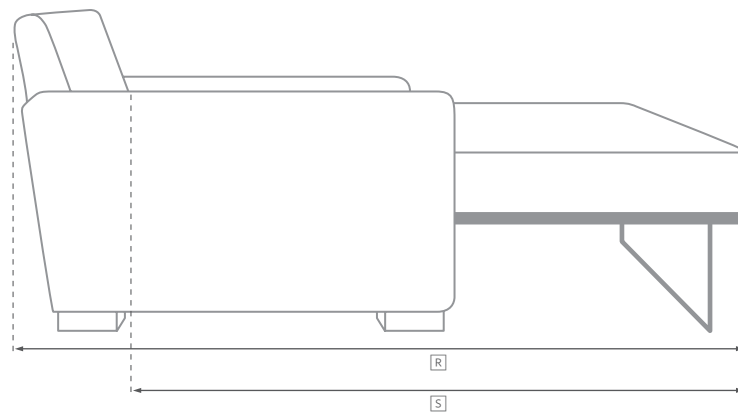
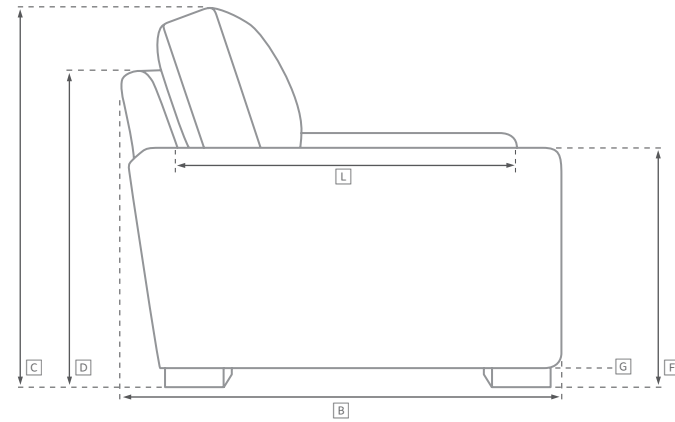
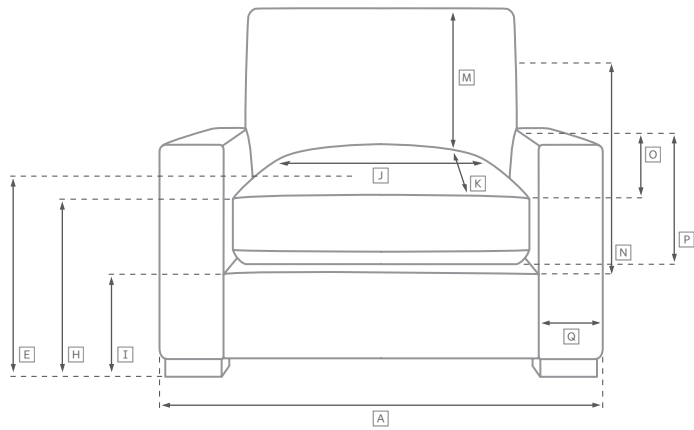

SOFA CHAISE SECTIONAL

Available in left and right-arm configurations.

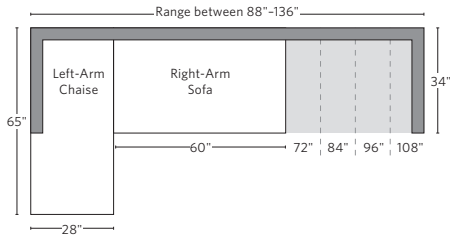

U-CHAISE SECTIONAL

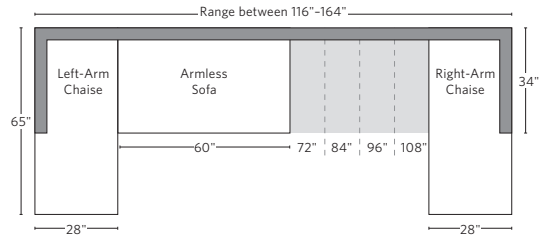

L-SECTIONAL

Available in left and right-arm configurations.

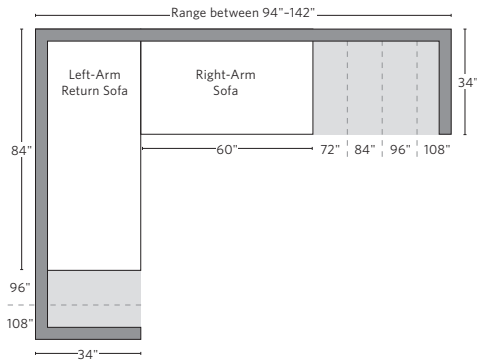

U-SOFA CHAISE SECTIONAL

Available in left and right-arm configurations.

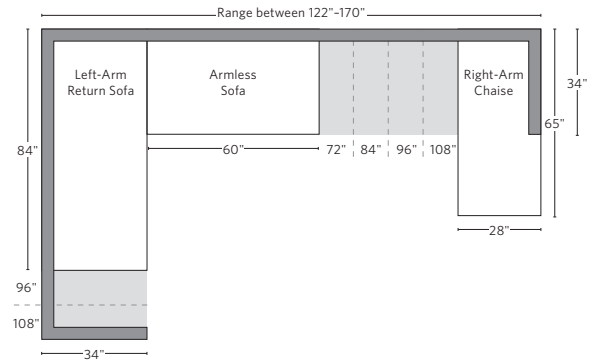

U-SOFA SECTIONAL

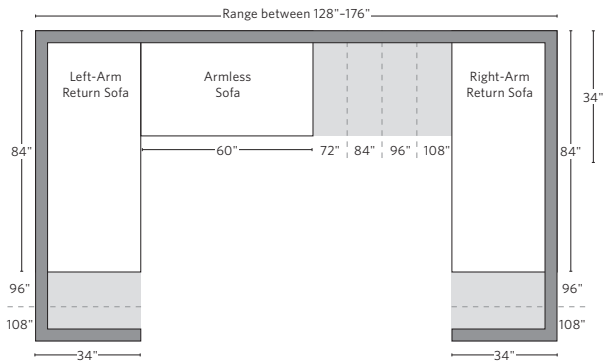

Multiple length options available.

SOFA CHAISE SECTIONAL

Available in left and right-arm configurations.

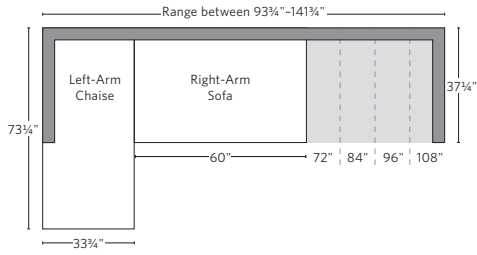

U-CHAISE SECTIONAL

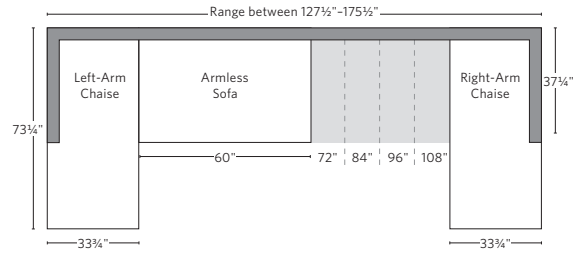

L-SECTIONAL

Available in left and right-arm configurations.

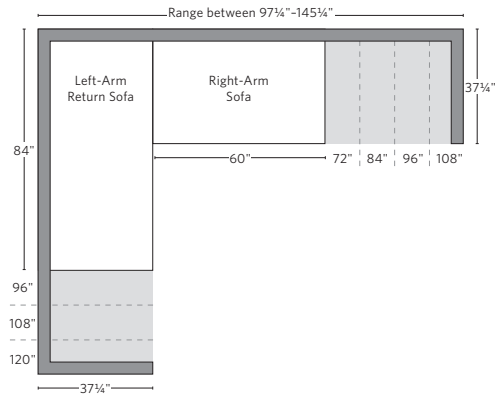

U-SOFA CHAISE SECTIONAL

Available in left and right-arm configurations.

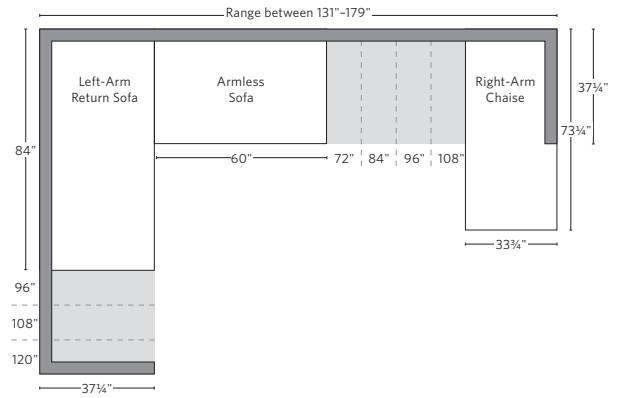

U-SOFA SECTIONAL

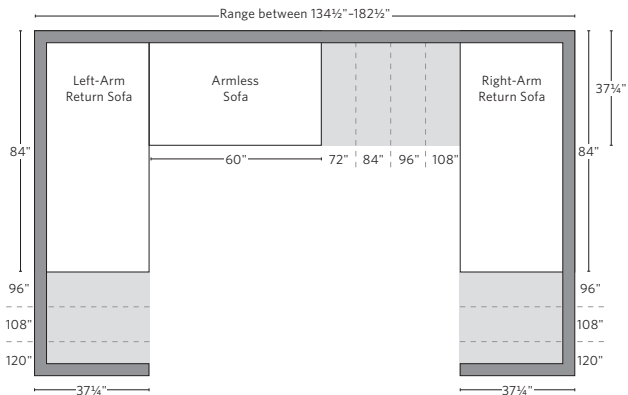

Multiple length options available.

SOFA CHAISE SECTIONAL

Available in left and right-arm configurations.

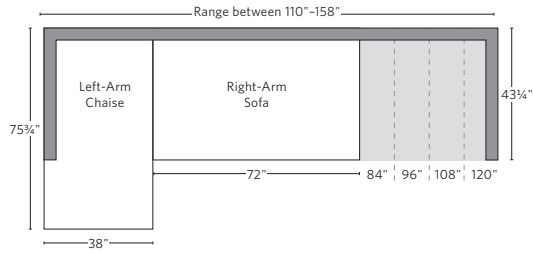

U-CHAISE SECTIONAL

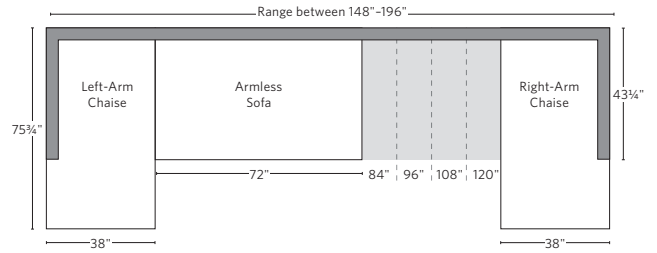

L-SECTIONAL

Available in left and right-arm configurations.

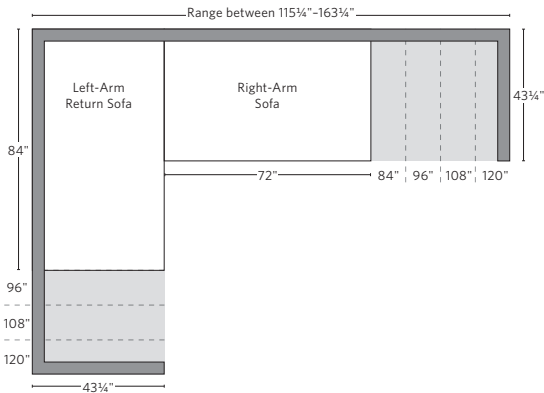

U-SOFA CHAISE SECTIONAL

Available in left and right-arm configurations.

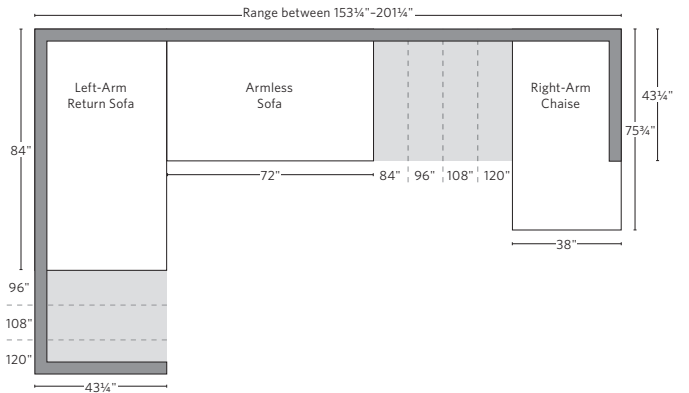

U-SOFA SECTIONAL

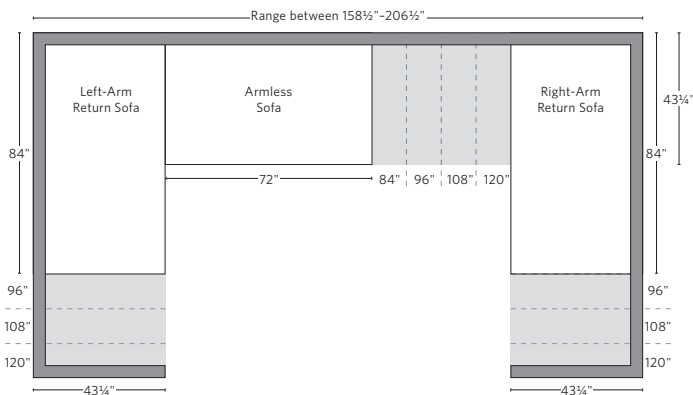

Multiple length options available.

## HOW WE MEASURE

We provide overall measurements (height, width and depth) for all our furniture. Furniture is measured at the tallest, deepest and widest points of the product, including overhangs, angles, outward curves, and arms.

RH

