

CAICOS TEAK SEATING COLLECTION



All dimensions are given in cm; all weights are given in kg. See the attached "Dimensions Diagram" sheet for more information on the keys used in this chart.

	OVERALL WIDTH A	OVERALL DEPTH B	OVERALL HEIGHT W/ CUSHION C	FRAME HEIGHT D	ARM HEIGHT E	ARM WIDTH F	FOOT HEIGHT G	SEAT HEIGHT W/ CUSHION H	SEAT HEIGHT (FLOOR TO FRAME) I	INSIDE SEAT WIDTH J	INSIDE SEAT DEPTH K	# OF BACK CUSHIONS	# OF SEAT CUSHIONS	WEIGHT
ARMLESS CHAIR	99	104	72	56	-	-	5	37	15	100	51	2	1	-
RIGHT-ARM CORNER CHAIR	104	104	72	56	-	-	5	37	15	104	51	2	1	-
LEFT-ARM CORNER CHAIR	104	104	72	56	-	-	5	37	15	104	51	2	1	-
OTTOMAN	99	99	37	15	-	-	5	37	15	99	99	1	1	-
CHAISE	71	206	25	15	-	-	5	25	15	-	206	-	1	-

OUTDOOR SEATING DIMENSIONS DIAGRAM

See the "Dimensions Sheet" for the measurements that correspond with the letters below.

RH

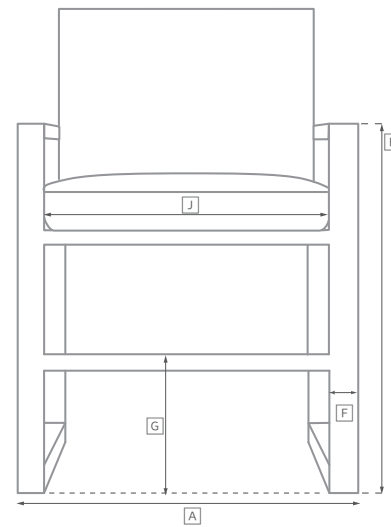

OUTDOOR SEATING DIMENSIONS DIAGRAM

See the "Dimensions Sheet" for the measurements that correspond with the letters below.

RH

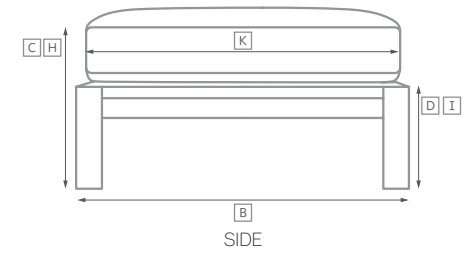

MODULAR SOFA

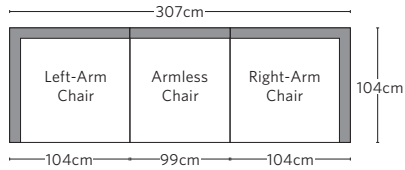

MODULAR SOFA CHAISE

Available in left- and right-arm configurations.

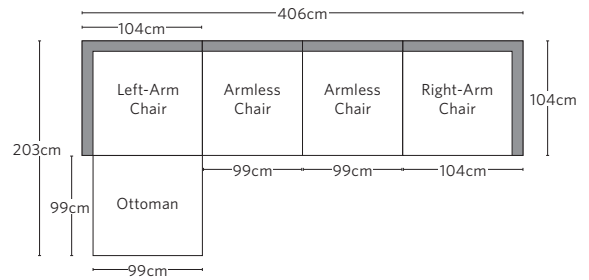

MODULAR L-SECTIONAL WITH COFFEE TABLE

Available in left- and right-arm configurations.

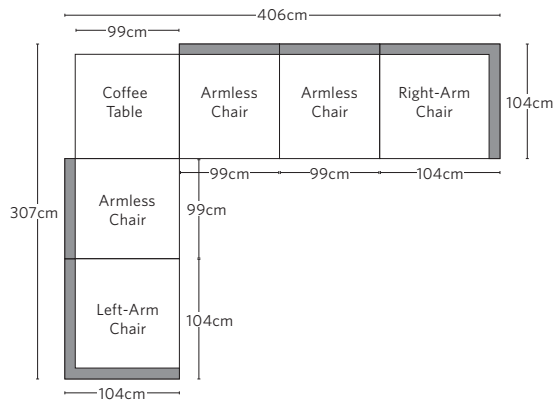

MODULAR U-CHAISE SECTIONAL

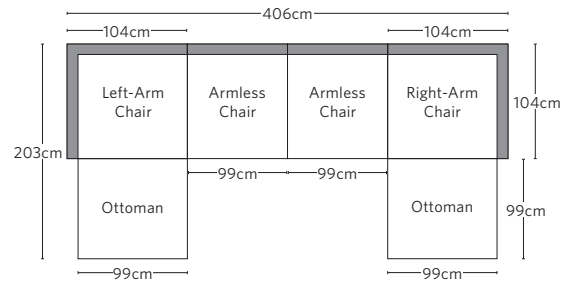

MODULAR U-SOFA SECTIONAL WITH COFFEE TABLES

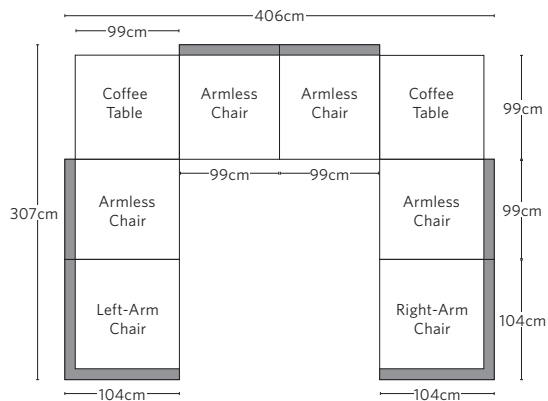

MODULAR U-SOFA CHAISE SECTIONAL

Available in left- and right-arm configurations.

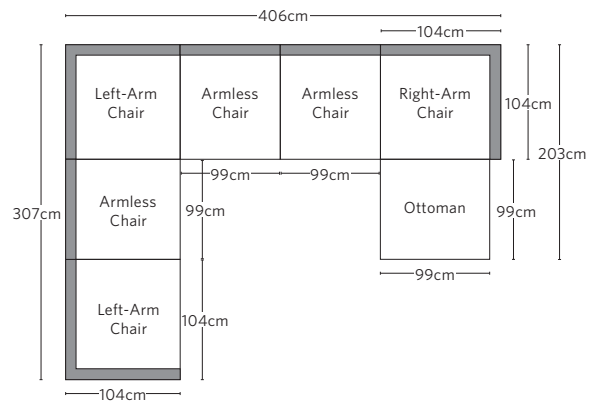

MODULAR SOFA CHAISE

Available in left- and right-arm configurations.

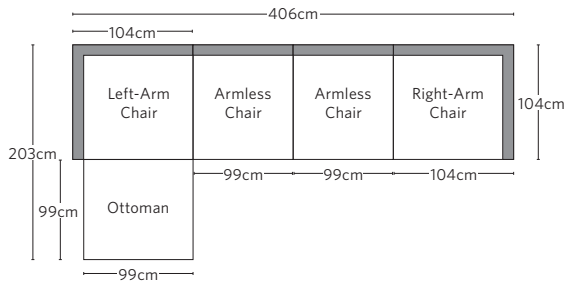

MODULAR L-SECTIONAL

Available in left- and right-arm configurations.

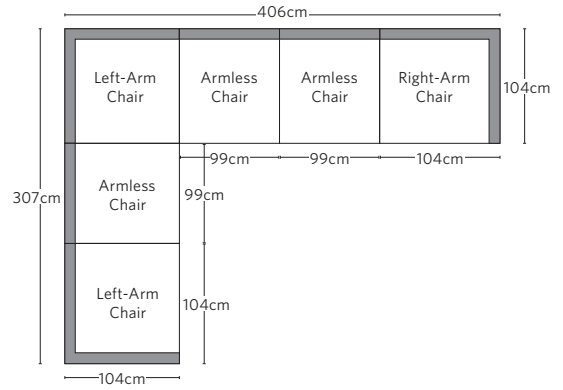

MODULAR U-SOFA SECTIONAL

